

ZERTS

INSERTS FOR PLASTICS

“Manufactured globally, supplied locally”

With almost 30 years of experience, engineering expertise and dynamic growth PENCOM has earned a reputation as one of the foremost global suppliers in the fastener industry. PENCOM’s “Manufactured globally, supplied locally” philosophy provides customers with a low cost global manufacturing advantage while still offering localized inventory and technical support. PENCOM’s Visible Inventory system offers real-time inventory management to meet the needs of our customers. The sensor-based technology automatically captures and electronically transmits stock quantities to eliminate min/max levels, uncertainty, MOQ’s and receiving.



Inserts provide sturdy, reusable threads in plastic materials. They help eliminate creep and maintain integrity of tensioned joints. PENCOM's inserts are suitable for a wide variety of installation methods and plastic material types and are commonly used in automotive, electronic and communications equipment, and consumer product applications. PENCOM's range of fasteners extends well beyond those presented in this catalog. Visit www.pencomsf.com or contact an Account Representative to discover PENCOM's engineering, manufacturing and distribution capabilities.

TABLE OF CONTENTS

Zerts Selection Guide	Page 6
Plastics Overview	Page 9
Installation Information	Page 10
Design and Performance Guidelines	Page 13

Heat/Ultrasonic Installed Inserts

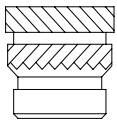

SHZ Straight Hole Zerts* Page 18

Offer rapid self-aligning installation into a wide variety of thermoplastics. The opposing helical knurls provide excellent pull-out and torque-out resistance.

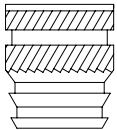

THZ Tapered Hole Zerts Page 24

Designed for installation into a hole with an 8° taper at the top – a favorite with molders. The combination of knurls and barbs provide high pull-out and torque-out performance. Choice of single and double barb styles.

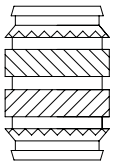

TWZ Twin Zerts Page 28

Feature a double-ended symmetrical design that assists automatic feeding by eliminating the need for orientation during installation. They are suitable for use with a wide variety of thermoplastics. Opposing helical knurls and knurled vanes provide superior pull-out and torque-out resistance.

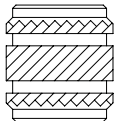

MNZ Miniature Zerts Page 34

Similar characteristics as the TWZ but in a miniature design. The compact size is ideal in small moldings where space is a concern.

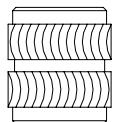

LSZ Low Stress Zerts Page 36

Developed with a rounded knurl pattern that reduces stress in notch sensitive amorphous thermoplastics. The double-ended symmetrical design assists automatic feeding by eliminating the need for orientation during installation.

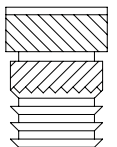

HCZ Hi-Capacity Zerts Page 40

Offer excellent pull-out and torque-out performance. They provide high process capability in high-fill plastics with reduced installation depth.

* Most popular in installation group

TABLE OF CONTENTS (CONTINUED)

Press-in Inserts (Expansion)

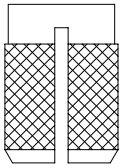

EDZ Expansion Diamond Zerts*

Page 44

Ideal for hard thermoset plastics. Installation of a mating screw expands the diamond knurls into the sides of the hole causing a thread locking effect.

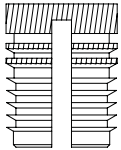

EFZ Expansion Fin Zerts

Page 48

Designed for use in a wide variety of thermoplastics. Installation of a mating screw expands the fins into the sides of the hole creating a thread locking effect. Helical knurls and plain and knurled vanes provide excellent pull-out and torque-out resistance.

Press-in Inserts (Free-running)

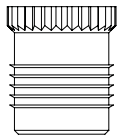

PFZ Press-in Fin Zerts

Page 51

Offer simple press-in installation for most thermoplastics. Similar to the EFZ but with a free-running thread. The combination of sharp fins and straight knurls provides exceptional performance.

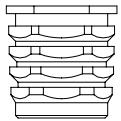

PHZ Press-in Hex Zerts

Page 55

Provide high pull-out resistance in most thermoplastics. Simple installation using a standard press eliminates the need for molding-in or costly heat/ultrasonic equipment.

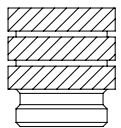

TSZ Thermo Set Zerts*

Page 58

Feature a sharp helical knurl pattern that “broaches” into thermosetting plastics reducing radial stresses in these hard and brittle materials.

Self-tapping Inserts

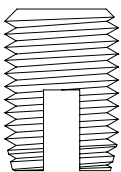

SSZ Screw Zerts*

Page 62

Offer self-tapping installation suitable for a wide variety of thermoplastics and thermosetting plastics. The external thread configuration is favorable where jack-out is unavoidable and provides high pull-out resistance in weak materials.

Mold-in Inserts

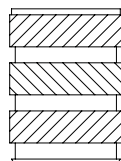

FTZ Fix Tite Zerts

Page 66

Feature a counterbore to facilitate placement on mold locating pins and aid start of mating fasteners. The opposing helical knurls and longer body produce outstanding resistance to pull-out and torque-out.

* Most popular in installation group

TABLE OF CONTENTS (CONTINUED)

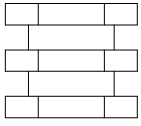

HXZ Molded Hex Zerts

Page 68

Hex shaped inserts provide high torque-out resistance when molded in soft thermoplastic materials. They are an excellent insert for rotational molding applications with thru-hole threads that are symmetrical and may be used from either end.

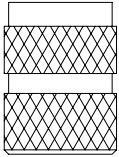

MBZ Molded Blind Zerts*

Page 71

Designed to be molded-in during the molding process. The blind end prevents plastic flow into the bottom of the insert and contaminating the threads. They have a diamond knurl which offers excellent performance.

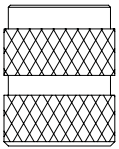

MTZ Molded Thru-Hole Zerts

Page 76

Designed to be molded-in during the molding process. The thru-thread allows for longer male thread engagement. They have a diamond knurl which offers excellent performance.

Options

Page 79

* Most popular in installation group

ZERTS SELECTION GUIDE

The main considerations governing insert selection are: type of plastic, installation method and insert performance. The tables below will assist the specifier in choosing the best insert for a given application. Additionally, custom inserts can be designed to suit specific requirements. Contact PENCOM to speak with a technical representative.

	SHZ	THZ	TWZ	MNZ	LSZ	HCZ	EDZ	EFZ	PFZ	PHZ	TSZ	SSZ	FTZ	HXZ	MBZ	MTZ
Hard Thermoplastics	★	★	★	★	●	★	●			●		●	★	●	★	★
Medium Thermoplastics	★	★	★	★	●	★	★	★	★	★		★	★	●	★	★
Soft Thermoplastics	★	★	★	★		★		★	★	★		★	★	★	★	★
Amorphous Thermoplastics	■		■	■	★								■		■	■
Thermosetting Polyester							●				●	★	★	●	★	★
Thermosetting (Other)							★				★	●	★	●	★	★
Thermoplastic Foams	●	●	●		●	●						★	★	●	★	★
Thermosetting Foams												★	★	●	★	★

- ★ Recommended
- Possible
- Possible but cracking may occur in brittle plastics

Zerts Selection Guide

POPULAR MATERIAL CHARACTERISTICS

Thermoplastics–Hard

Filled Nylon (Filled Polyamide) PBT
 (Polybutylene Terephthalate)
 PC/ABS Blend (Polycarbonate / Acrylonitrile Butadiene Styrene)
 PPS (Polyphenylene Sulfid)

Thermoplastics–Medium

ABS (Acrylonitrile Butadiene Styrene)
 Nylon (Polyamide)
 POM (Acetal)
 PVC (Polyvinyl Chloride)

Thermoplastics–Soft

HDPE (High-density Polyethylene)
 PE (Polyethylene)
 PP (Polypropylene)

Amorphous Thermoplastics

Acrylic
 PC (Polycarbonate)

Thermosetting Plastics

Polyesters: BMC, DMC, SMC
 Others: Phenolic, Ureas, Tufnol,
 Rigid polyurethane, Epoxy resins, Vinyl esthers

ZERTS SELECTION GUIDE (CONTINUED)

INSTALLATION METHODS

	SHZ	THZ	TWZ	MNZ	LSZ	HCZ	EDZ	EFZ	PFZ	PHZ	TSZ	SSZ	FTZ	HXZ	MBZ	MTZ
Hand Tools							★	★				●				
Simple Press							★	★	★	★	★					
Direct Heat	★	★	★	★	★	★							●			
Ultrasonic	★	★				★										
Tapping Machine												★				
Molded-in	●	●	●	●	●	●							★	★	★	★
Fully Automated	★	★	★	★	★	★	★	★	★		★	●	●		●	●

- ★ Recommended
- Possible

INSERT ATTRIBUTES

	SHZ	THZ	TWZ	MNZ	LSZ	HCZ	EDZ	EFZ	PFZ	PHZ	TSZ	SSZ	FTZ	HXZ	MBZ	MTZ
Pull-out	★	★	★	★	★	★	●	●	●	●	●	★	★	★	★	★
Torque-out	★	★	★	★	★	★	●	●	●	●	★		★	★	★	★
Jack-out	★	★	★	★	★	★	●	●	●	●	●	★	★	★	★	★
Free-running Thread	Y	Y	Y	Y	Y	Y	N	N	Y	Y	Y	Y	Y	Y/N	N	Y
Thread Locking Effect	N	N	N	N	N	N	Y	Y	N	N	N	N	N	N	N	N
Bi-directional	N	N	Y	Y	Y	N	N	N	N	N	N	N	N	Y/N	N	N
Headed Option	Y	N	N	Y	Y	N	Y	N	Y	N	Y	Y	N	N	N	N
Stud Option	Y	N	Y	N	Y	N	N	N	Y	N	Y	Y	N	N	N	N

- ★ High
- Moderate

ZERTS SELECTION GUIDE (CONTINUED)

	SHZ	THZ	TWZ	MNZ	LSZ	HCZ	EDZ	EFZ	PFZ	PHZ	TSZ	SSZ	FTZ	HXZ	MBZ	MTZ
Brass	A	A	A	A	A	A	A	A	A	S	A	A	A	A	A	A
Stainless Steel	A	S	S	S	S	S	S	S	S	A	S	A	S	S	A	A
Aluminum	S	S	S	S	S	S	S	S	S	A	S	S	S	S	S	S

A Standard

S Special

PLASTICS OVERVIEW

Commercial plastics can be categorized into four main types: thermoplastics, thermosetting plastics, foams, and elastomers. Thermoplastics and thermosetting plastics are most suitable to insert installation and will be summarily explained.

Thermoplastics soften and melt at elevated temperatures. They can be divided into amorphous or semi-crystalline polymer sub-types depending on their structure at room temperature. Amorphous polymers have a random molecular structure and soften gradually with rising temperatures. They are resistant to creep (deformation due to prolonged stress) and impact, but sensitive to stress failure and have limited chemical/solvent resistance. Common amorphous polymers include ABS (acrylonitrile butadiene styrene), PVC (polyvinyl chloride) and PC (polycarbonate). Semi-crystalline polymers have a more ordered molecular structure with a distinct and limited melting point range that is generally above amorphous thermoplastics. They are more resistant to chemicals, fatigue, stress cracking and wear but have a tendency to creep under sustained loads. PET (polyethylene terephthalate) and PEEK (Polyetheretherketone) are typical examples. Polyamide, or nylon, can be either amorphous or semi-crystalline depending on the blending.

During formation, thermosetting plastics experience an irreversible chemical change and cannot be softened with heat. They are durable and resistant to heat. Examples include phenolic, urea and epoxy resins.

The physical characteristics of plastics can be enhanced by the addition of fillers and plasticizers depending on the application. They are used to increase strength and resistance to creep, minimize shrinkage, modify conductive and thermal properties and reduce cost. However, these additives can increase sensitivity to stress and influence the installation and performance of inserts as well.

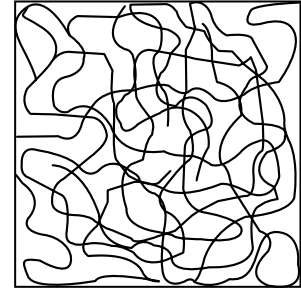

Random arrangement of polymer chains in amorphous thermoplastic

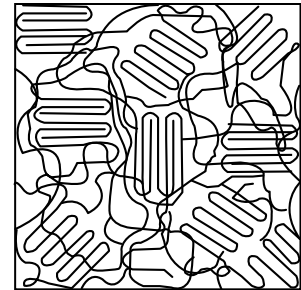

Ordered arrangement of polymer chains in semi-crystalline thermoplastic

INSTALLATION INFORMATION

Ultrasonic

Ultrasonic is the most common insert installation method for thermoplastics. A molded or drilled hole receives an insert that has a slightly larger diameter to create a small amount of interference and guide the insert into place. A "horn" contacts the top of the insert and imparts ultrasonic vibrations which travel through the insert. Frictional heat is generated at the insert/plastic interface causing localized temporary melting of the plastic. The insert is pressed into place with the horn allowing the molten material to flow into the external knurls, the vibrations cease and pressure is maintained until the plastic solidifies preventing back-out of the insert. Advantages of ultrasonic installation include: reduced cycle times, lower induced stress as compared to mold-in or press-in inserts, ability to install multiple inserts simultaneously, suitability for automated operations, and repeatable and consistent results as compared with heat-only installation. Because the method requires temporary melting of the plastic, ultrasonic installation is not recommended for thermosetting plastics.

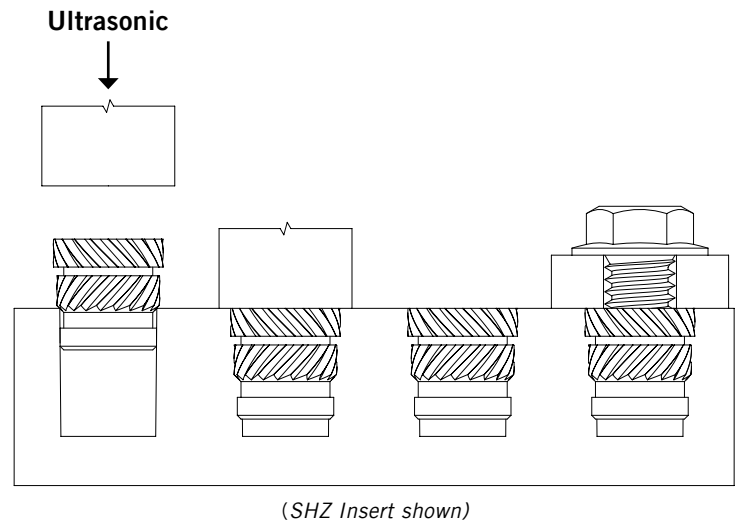

Heat

Similar to ultrasonic installation, inserts installed using heat begin with a molded or drilled hole that receives an insert with a slightly larger diameter to create a small amount of interference and guide the insert into place. The heated tip of an insertion press contacts the top surface of the insert, as well as, the internal threads. The insert is heated via thermal conduction and pressed into place once the proper melting temperature of the plastic is reached. Once installed, the heated press tip is retracted and the plastic solidifies locking the insert in place. Since the entire insert is heated, it takes longer to cool after installation thus providing a natural stress relief for the plastic. However, a small amount of back-out of the insert may occur. While somewhat slower than ultrasonic, advantages of heat installation include: excellent insert performance, ability to simultaneously install multiple inserts on different levels, more quiet and less expensive equipment required compared to ultrasonic, and more favorable results with larger inserts.

Because the method requires temporary melting of the plastic, heat installation is not recommended for thermosetting plastics.

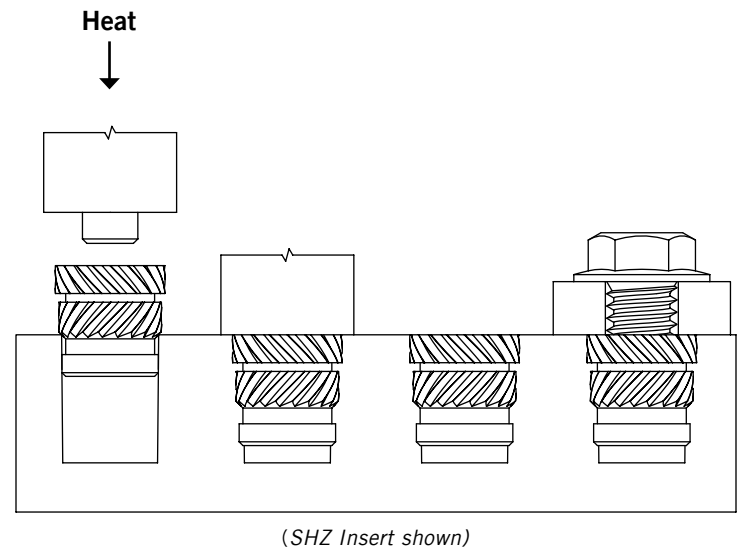

INSTALLATION INFORMATION (CONTINUED)

Press-in (Expansion)

Designed for non-critical applications, expansion-type inserts sacrifice strength for ease of installation. They may be using simply pressed into a molded or drilled hole using hand tools or standard press. Installation of the mating screw expands the insert and forces the knurls or fins in to the sides of the mating hold creating torque-out and pull-out resistance and somewhat of a thread locking effect. Because heat or ultrasonic vibration is not required for installation, the diamond-knurled and fin versions are popular for use with hard thermosetting plastics.

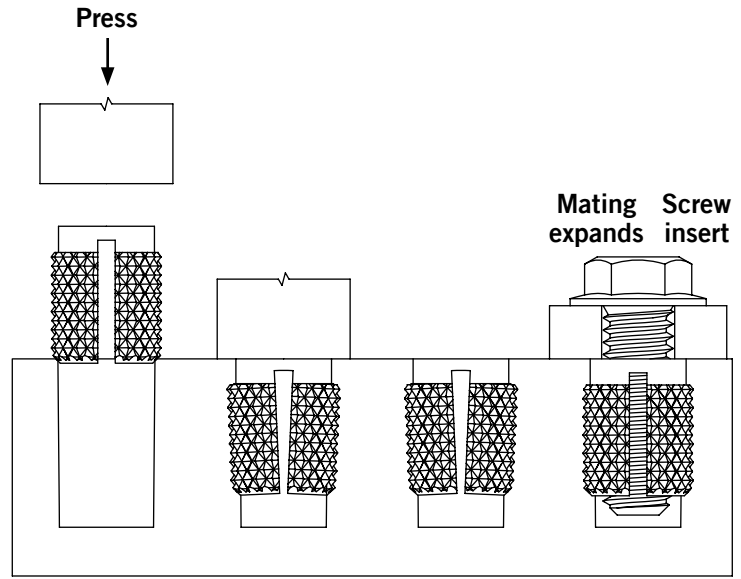

(EDZ Insert shown)

Press-in (Free-running)

For applications where ease of installation and reduced cost are more important than torque-out and pull-out performance, press-in inserts with a free-running thread are cost-effective solutions. The insert diameter is slightly larger than the hole diameter but with a pilot end that's marginally smaller than the hole to guide the insert. Pressing the insert into cold plastic creates undesirable stress so increased boss wall thickness is usually necessary. Performance can be improved if the insert installation is done while the mating plastic is still warm from molding.

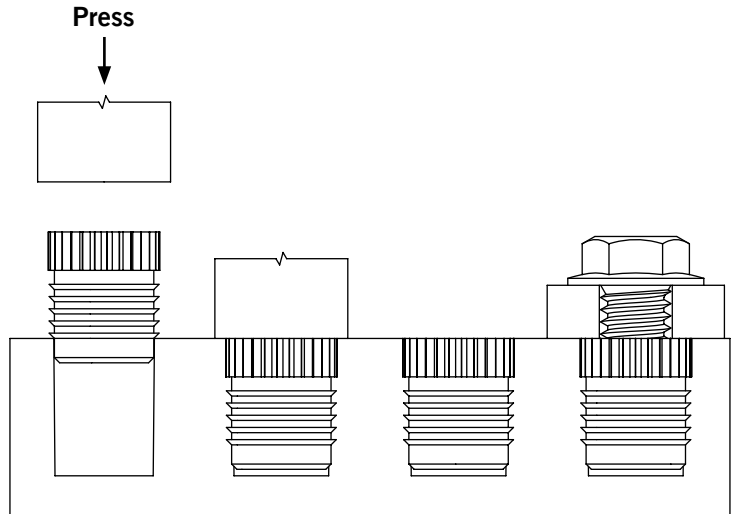

(PFZ Insert shown)

INSTALLATION INFORMATION (CONTINUED)

Self-tapping

Self-tapping inserts for post-molding installation are manufactured with external threads to create the maximum shear surface area while minimizing induced stress with the mating plastic component. A thread-cutting groove makes these inserts suitable for thermoset and brittle materials. A tapping head attaches to the insert and transfers the torque to install the insert. The thread friction between the insert and plastic component is greater than the internal thread so that tapping tool is easily removed, as well as, any mating fastener without worry of insert back-out. The self-tapping design is suitable for weak materials with low core strengths and where jack-out may be unavoidable.

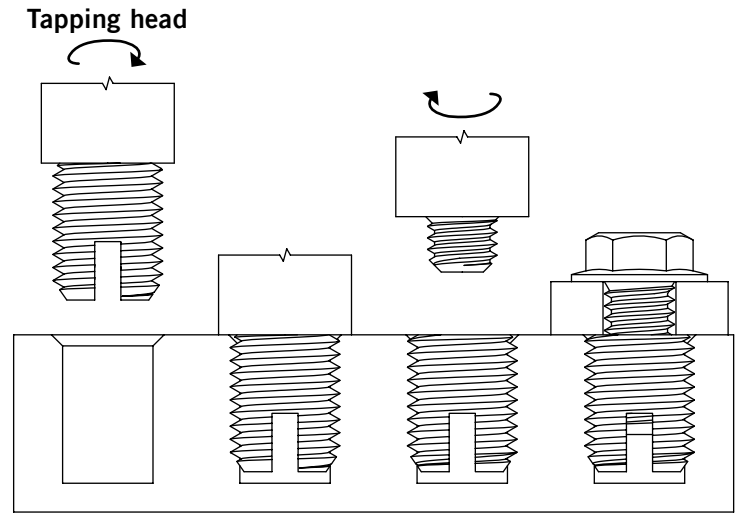

(SSZ Insert shown)

Mold-in

While having the largest overall installation cost, mold-in inserts provide the best performance. When the mold is open, the inserts are placed on guide pins in the cavity which hold the inserts in place. The inserts have a reduced-tolerance minor diameter to maintain a good fit with the pins and alignment with the plastic component. After encapsulation by the plastic, the mold opens and the pins are retracted exposing only the insert threads. Because the inserts must be loaded on the core pins, total molding time is increased, as well as, down time to repair mold damage caused when an insert is improperly loaded. Plastic sink marks and internal stresses are sometimes a concern because of the different cooling rates of the plastic and inserts. Mold-in inserts are popular for use with thermosetting plastics because of the limited post-mold insert options and inherent strength.

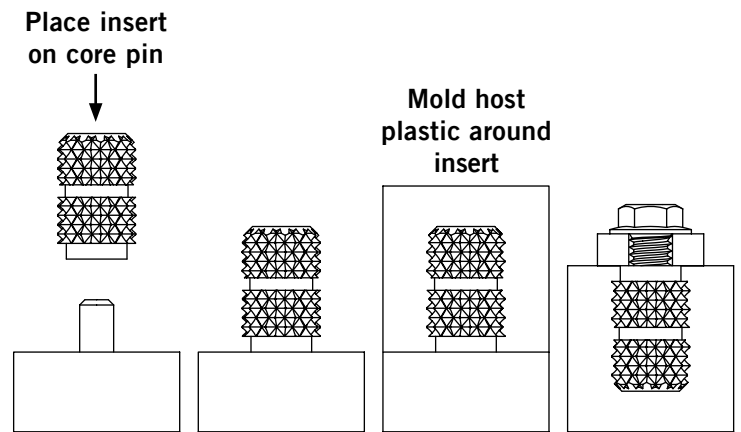

(MBZ Insert shown)

DESIGN AND PERFORMANCE GUIDELINES

Performance Terminology

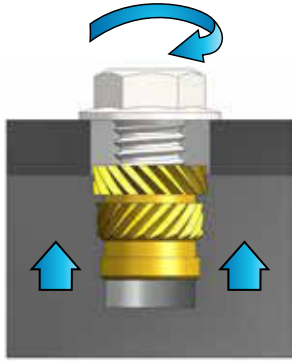

Jack-out

Rotational force acting to pull the insert out of the host material. The condition results from mating component not bearing directly on the insert.

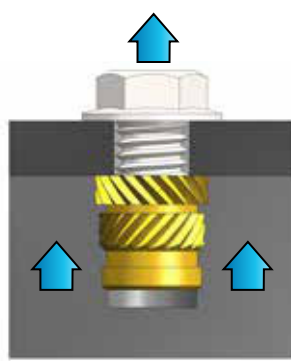

Pull-out

Axial force acting to pull the insert out of the host material.

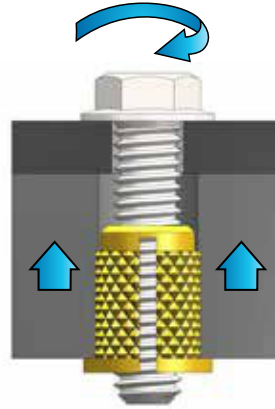

Pull-thru

Insert installed in a thru-hole and mating screw installed in pilot end of insert.

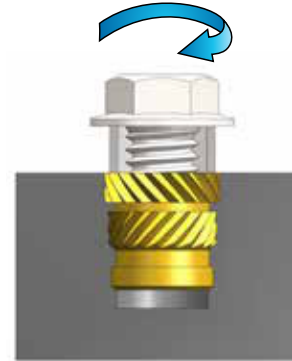

Torque-out

Rotational force acting to cause insert failure within the host material.

Insert Design

Inserts develop their strength by having the host plastic form around integral knurl bands, recesses and vanes (fins). In general, knurls increase an insert's resistance to torque while recesses and vanes increase pull-out resistance. The greater the insert length the greater the performance due to the increase size or number of insert features. Straightknurls offer the greatest torque resistance while helical knurls offer a compromise between torque and pull-out resistance. Ease of installation and host material type are additional design considerations. Therefore, the goal of the insert design is to achieve the greatest performance for a specific application.

Some inserts are offered in a headed configuration. This option:

- Provides a larger bearing surface area for the mating component
- Increases ultrasonic horn contact area
- Pushes material back down that may have been displaced up the insert sides during installation.
- Reduces the likelihood of jack-out
- Offers greater resistance in pull-thru applications

DESIGN AND PERFORMANCE GUIDELINES (CONTINUED)

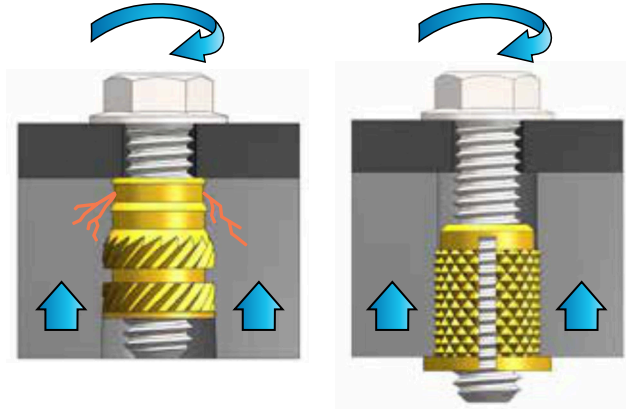

Non-headed inserts used in pull-thru applications may cause the host plastic to crack and should be avoided.

Headed inserts offer excellent pull-thru performance without causing damage to the host plastic.

Insert Installation

Regardless of the insert design or installation method, installing an insert straight in the hole is critical. Although inserts have a taper and/or lead-in to facilitate self-alignment, failure to maintain axial integrity with the hole can result in boss side loads which may cause cracking.

After installation, the end of the insert should be flush or within .005" above the host plastic to achieve maximum performance. With heat installation, the insert may back out somewhat and is considered normal. An insert should never be installed below the surface as this can lead to jack-out.

INCORRECT



Insert installed below the surface of the host plastic will be subjected to jack-out.

INCORRECT

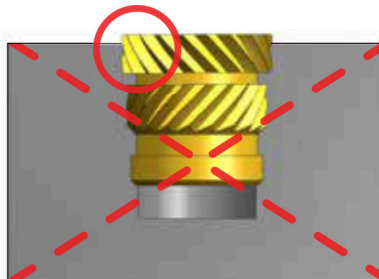

Insert installed above the surface of the host plastic will not achieve optimal effectiveness.

CORRECT



Inserts should be installed flush or within .005" above the host plastic for the best performance.

DESIGN AND PERFORMANCE GUIDELINES (CONTINUED)

Boss Design

To achieve maximum performance, the boss must be correctly sized according to diameter and taper. Hole sizes shown in the bulletin are for post-mold conditions because as plastic cools it shrinks and hole sizes may change. Oversized holes result in decreased insert performance while undersized holes lead to stresses in the boss walls and possibly flash at the hole edge after insert installation.

If fillers are used, the hole sizes may need to be adjusted as follows: increase hole diameters .003" for filler contents greater than or equal to 15%; increase hole diameters .006" for filler contents greater than or equal to 35%; interpolate hole diameter increases for intermediate filler contents; filler contents greater than 40% may result in problems with installation and/or performance. PENCOM recommends pre-production testing to verify the correct boss hole size. All inserts in this bulletin require boss holes with a 0.5° to 8° total inclusive taper depending on the insert type. Inserts are designed to fit a particular boss hole configuration and should not be interchangeable with other boss designs. Greater boss hole tapers are preferred by molders due to an easier release from insert locating core pins.

Boss hole depth is critical to achieving a flush insert installation. For ultrasonic/heat installed inserts the hole depth should be at least .039" (1.00mm) greater than the length of the insert to allow space for forward displaced material that may otherwise be forced into and contaminate internal threads. Hole depth should also be sufficient to prevent the assembly screw from bottoming out in the hole and causing jack-out.

Minimum boss wall thicknesses shown are for reference and may need to be increased to avoid bulging and remain strong enough to resist assembly torque. Post-mold quality is important as poor knit lines can lead to failures. Cold pressed inserts require larger wall thicknesses due to the greater stresses imposed. Installing these inserts while the plastic is still warm reduces boss wall internal stresses.

Countersinks and counterbores should be avoided on all post-mold installed inserts except self-tapping inserts. This hole treatment could interfere with the lead-in features of an insert and influence the self-aligning characteristics.

When installing a studded or blind threaded insert, a small vent should be added to the bottom of a blind hole to allow trapped air to escape. Otherwise, the pressure buildup may distort the plastic surface around the insert and make consistent installation results difficult.

DESIGN AND PERFORMANCE GUIDELINES (CONTINUED)

Mating Component

To prevent jack-out, it is very important that the clearance hole of the mating component is sized correctly. The clearance hole should be larger than the assembly screw yet smaller than the outside diameter of the insert so that the insert, not the host plastic, carries the compressive load. If the clearance hole must be oversized for misalignment purposes, a headed insert is recommended to increase the insert bearing area surface.

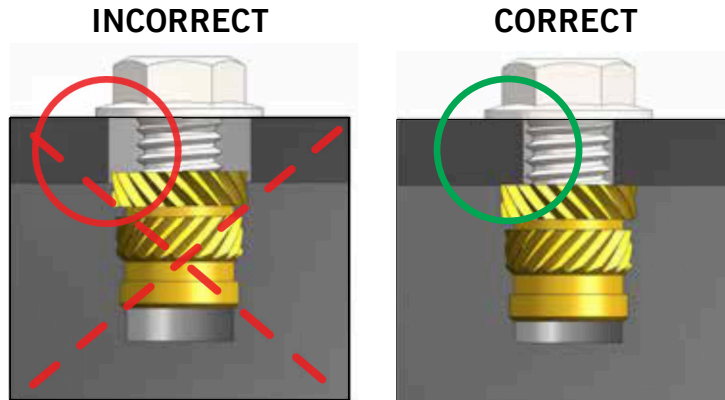

Oversized clearance hole of mating component prevents bearing contact on insert causing jack-out.

Correctly sized mating component clearance hole.

DESIGN AND PERFORMANCE GUIDELINES (CONTINUED)

Compression Limiters

In bolted assemblies where the mating component is also plastic, creep or stress relaxation resulting from sustained compressive loads may be prevented by using a compression limiter. A compression limiter maintains joint integrity by absorbing the load between the fastener and insert and prevents joint loosening due to creep. The compression limiter should be large enough to provide clearance for the mating fastener yet small enough to bear directly on the end of the insert. A headed insert may be required for compression limiters with large thru-holes. Additionally, the length of the compression limiter must be equal to or slightly larger than the thickness of the mating component to prevent plastic creep. As most requirements are different, compression limiters are designed and manufactured for each specific application.

INCORRECT

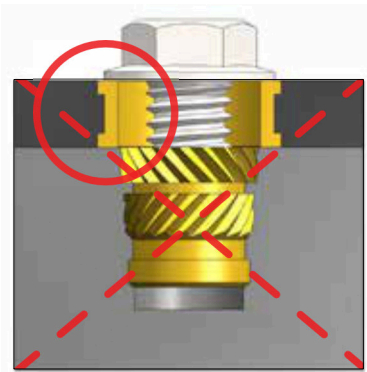

Oversized clearance hole of mating compression limiter prevents bearing on the insert causing jack-out.

INCORRECT

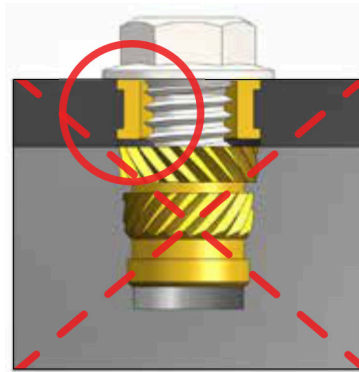

Incorrect length of compression limiter can lead to creep of the plastic mating component.

CORRECT



Correctly sized compression limiter absorbs full compression load of the mating fastener.



SHZ

Straight Hole Zerts

FEATURES

- Rapid self-aligning installation using heat or ultrasonic.
- Opposing helical knurls provide excellent pull-out and torque-out resistance.
- Thin boss walls permit compact design.
- Available in a wide variety of thread sizes, stud lengths and options.



PART DESCRIPTION EXAMPLE

SHZS	—	632	—	250 X 375	—	SS
T		T		T		T
Series Code		Insert or Stud Thread Code		Insert Length Code		Stud Length Code ¹
						Material Code ²

- (1) Omit stud length code for non-studded inserts.
- (2) SS material code designates stainless steel. Standard insert material is brass. Omit SS material code for brass inserts. Custom materials and finishes available by request.

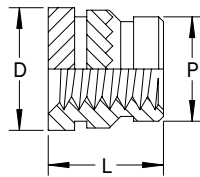

Insert
Series Code SHZ

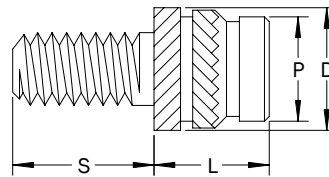

Insert w/ Stud
Series Code SHZS

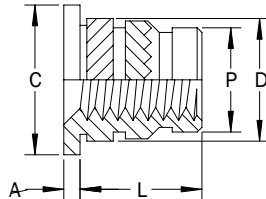

Headed Insert
Series Code SHZH

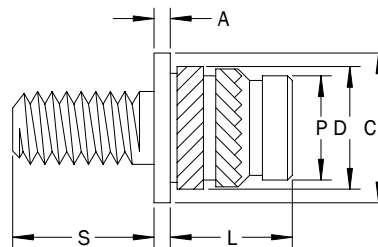

Headed Insert w/ Stud
Series Code SHZHS

SHZ Straight Hole Zerts

GENERAL

	Insert Thread	Insert Thread Code	Boss		A Head Thickness	C Head Diameter	D Insert Diameter	P Pilot Diameter
			B Hole Dia. +.004 - .000	W Wall Thickness Min.				
INCH	0-80	080	.100	.051	—	—	.116	.095
	2-56	256	.126	.051	.021	.187	.141	.123
	4-40	440	.157	.063	.024	.218	.181	.154
	6-32	632	.189	.071	.030	.250	.214	.185
	8-32	832	.220	.083	.036	.281	.248	.218
	10-24	1024	.252	.102	.043	.312	.278	.249
	10-32	1032	.252	.102	.043	.312	.278	.249
	1/4-20	2520	.315	.130	.053	.375	.341	.312
	1/4-28	2528	.315	.130	.053	.375	.341	.312
	5/16-18	3118	.378	.177	.053	.437	.403	.374
	5/16-24	3124	.378	.177	.053	.437	.403	.374
	3/8-16	3716	.469	.236	.063	.551	.494	.465
	3/8-24	3724	.469	.236	.063	.551	.494	.465
	1/8-NPT	125NPT	.453	.236	—	—	.479	.450
	1/2-13	5013	.630	.315	.079	.748	.657	.622
	1/2-20	5020	.630	.315	.079	.748	.657	.622

(1) All dimensions are in inches and reference unless toleranced.

	Insert Thread	Insert Thread Code	Boss		A Head Thickness	C Head Diameter	D Insert Diameter	P Pilot Diameter
			B Hole Dia. +0.10 - 0.00	W Wall Thickness Min.				
METRIC	M2 x 0.4	M2	3.20	1.30	0.53	4.80	3.60	3.10
	M2.5 x 0.45	M2.5	4.00	1.60	0.61	5.50	4.60	3.90
	M3 x 0.5	M3	4.00	1.60	0.61	5.50	4.60	3.90
	M3.5 x 0.6	M3.5	4.80	1.80	0.76	6.40	5.40	4.70
	M4 x 0.7	M4	5.60	2.10	0.91	7.10	6.30	5.50
	M5 x 0.8	M5	6.40	2.60	1.09	7.90	7.10	6.30
	M6 x 1.0	M6	8.00	3.30	1.35	9.50	8.70	7.90
	M8 x 1.25	M8	9.60	4.50	1.35	11.10	10.20	9.50
	M10 x 1.5	M10	11.90	6.00	1.60	14.00	12.60	11.80
	M12 x 1.75	M12	16.00	8.00	2.00	19.00	16.70	15.80

(1) All dimensions are in millimeters and reference unless toleranced.

INSERT LENGTH

INCH	Insert Thread	L Insert Length	Insert Length Code
	0-80	.125 ²	125
	2-56	.100	100
		.115	115
		.125	125
		.138	138
		.157 ²	157
	4-40	.096	096
		.140	140
		.170	170
.226 ²		226	
.250		250	
.321		321	
6-32	.125	125	
	.150	150	
	.205	205	
	.226	226	
	.250	250	
	.281 ²	281	
	.375	375	

- (1) All dimensions are in inches and reference unless toleranced.
- (2) Preferred insert length.
- (3) Custom insert lengths available by request.

INCH (CONTINUED)	Insert Thread	L Insert Length	Insert Length Code
	8-32	.115	115
		.150	150
		.185	185
		.250	250
		.281	281
		.321 ²	321
	10-24 10-32	.185	185
		.226	226
		.250	250
		.310	310
		.375 ²	375
		.400	400
	1/4-20 1/4-28	.250	250
		.312	312
		.348	348
		.500 ²	500
	5/16-18 5/16-24	.500 ²	500
3/8-16 3/8-24	.500 ²	500	
1/8 NPT	.625 ²	625	
1/2-13 1/2-20	.625 ²	625	

- (1) All dimensions are in inches and reference unless toleranced.
- (2) Preferred insert length.
- (3) Custom insert lengths available by request.

METRIC	Insert Thread	L Insert Length	Insert Length Code
	M2 x 0.4	2.50	2.50
		3.18	3.18
		4.00 ²	4.00
	M2.5 x 0.45	3.56	3.56
		5.74 ²	5.74
	M3 x 0.5	4.00	4.00
		4.32	4.32
		5.00	5.00
		5.21	5.21
		5.74 ²	5.74
	M3.5 x 0.6	3.80	3.80
		5.00	5.00
		7.14 ²	7.14
	M4 x 0.7	4.00	4.00
		4.70	4.70
		5.51	5.51
		5.74	5.74
		6.35	6.35
		8.15 ²	8.15
	M5 x 0.8	5.80	5.80
		6.35	6.35
		9.50 ²	9.50
	M6 x 1.0	6.35	6.35
		6.80	6.80
7.90		7.90	
12.70 ²		12.70	
M8 x 1.25	12.70 ²	12.70	
M10 x 1.5	12.70 ²	12.70	
M12 x 1.75	15.90 ²	15.90	

- (1) All dimensions are in millimeters and reference unless toleranced.
- (2) Preferred insert length.
- (3) Custom insert lengths available by request.

STUD LENGTH

	Stud Thread	Stud Thread Code	D Insert Diameter	S - Stud Length									
				.187	.250	.312	.375	.437	.500	.625	.750	.875	1.000
				Stud Length Code									
INCH	0-80	080	.116	187	250	—	—	—	—	—	—	—	—
	2-56	256	.141	187	250	312	—	—	—	—	—	—	—
	4-40	440	.181	187	250	312	375	437	—	—	—	—	—
	6-32	632	.214	187	250	312	375	437	500	—	—	—	—
	8-32	832	.248	187	250	312	375	437	500	625	—	—	—
	10-24	1024	.278	187	250	312	375	437	500	625	750	—	—
	10-32	1032	.278	187	250	312	375	437	500	625	750	—	—
	1/4-20	2520	.341	—	250	312	375	437	500	625	750	875	1000
	1/4-28	2528	.341	—	250	312	375	437	500	625	750	875	1000
	5/16-18	3118	.403	—	—	312	375	437	500	625	750	875	1000
	5/16-24	3124	.403	—	—	312	375	437	500	625	750	875	1000
	3/8-16	3716	.494	—	—	—	375	437	500	625	750	875	1000
	3/8-24	3724	.494	—	—	—	375	437	500	625	750	875	1000
	1/8-NPT	125NPT	.479	—	—	—	375	437	500	625	750	875	1000
	1/2-13	5013	.657	—	—	—	—	—	500	625	750	875	1000
	1/2-20	5020	.657	—	—	—	—	—	500	625	750	875	1000

- (1) All dimensions are in inches and reference unless tolerated.
 (2) Custom stud lengths available by request.

STUD LENGTH (CONTINUED)

METRIC	Stud Thread	Stud Thread Code	D Insert Diameter	S - Stud Length									
				5.00	6.00	8.00	10.00	12.00	14.00	16.00	18.00	20.00	25.00
				Stud Length Code									
	M2 x 0.4	M2	3.60	5.00	6.00	8.00	—	—	—	—	—	—	—
	M2.5 x 0.45	M2.5	4.60	5.00	6.00	8.00	10.00	—	—	—	—	—	—
	M3 x 0.5	M3	4.60	5.00	6.00	8.00	10.00	12.00	—	—	—	—	—
	M3.5 x 0.6	M3.5	5.40	5.00	6.00	8.00	10.00	12.00	14.00	—	—	—	—
	M4 x 0.7	M4	6.30	5.00	6.00	8.00	10.00	12.00	14.00	16.00	—	—	—
	M5 x 0.8	M5	7.10	5.00	6.00	8.00	10.00	12.00	14.00	16.00	18.00	20.00	—
	M6 x 1.00	M6	8.70	—	6.00	8.00	10.00	12.00	14.00	16.00	18.00	20.00	25.00
	M8 x 1.25	M8	10.20	—	—	8.00	10.00	12.00	14.00	16.00	18.00	20.00	25.00
	M10 x 1.5	M10	12.60	—	—	—	10.00	12.00	14.00	16.00	18.00	20.00	25.00
	M12 x 1.75	M12	16.70	—	—	—	—	12.00	14.00	16.00	18.00	20.00	25.00

- (1) All dimensions are in millimeters and reference unless toleranced.
- (2) Custom stud lengths available by request.

BOSS DESIGN RECOMMENDATION

The SHZ Straight Hole Zert is designed to be installed into a straight molded hole with a 1° inclusive taper. The top of the hole should not be countersunk or counterbored as this will decrease the insert's performance. The recommended hole size applies at the point reached by the bottom of the insert. Molded holes should be used wherever possible as drilled holes may result in diminished performance. Minimum boss wall thicknesses shown are for reference and may vary depending on the type of plastic.

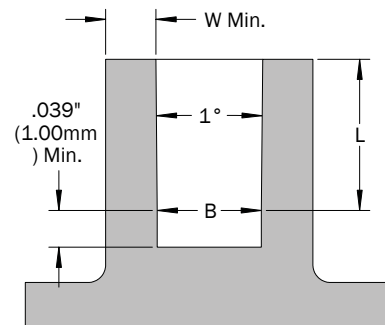

INSTALLATION

The insert may be installed by pre-heating or ultrasonic vibration methods. When using heat, the insert should be hot enough to soften the plastic without melting it to avoid flash around the top. Ultrasonic vibration should be applied using low amplitude and the minimum amount of power necessary to satisfactorily soften the plastic. In both methods, avoid excessive pressure that would force an insert into a hole without allowing the plastic to properly soften and flow around the insert features.

PERFORMANCE

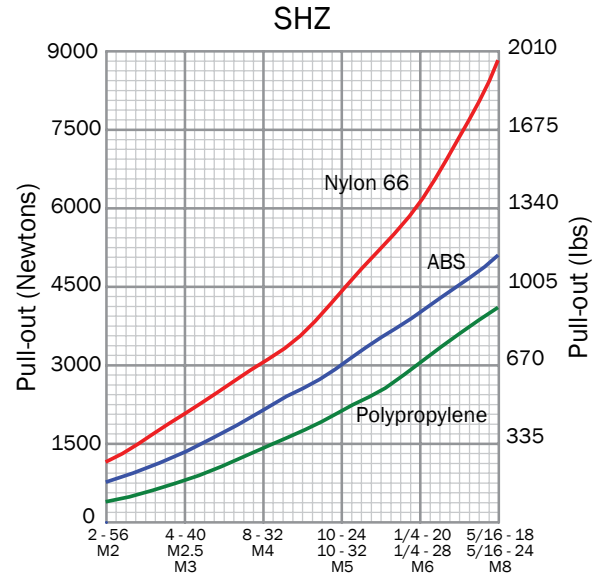

(1) Performance data shown is for preferred insert lengths and reference only. Variations in application, boss material type and size, and installation method will affect the loads. PENCOM strongly encourages testing in the application.



THZ

Tapered Hole Zerts

FEATURES

- Designed to be used in an 8° tapered hole.
- Rapid self-aligning installation using heat or ultrasonic.
- Combination of knurls and vanes provide high pull-out and torque-out resistance.
- Circular flange creates an attractive installation by preventing escape of plastic.
- Available in a wide variety of thread sizes and lengths.



PART DESCRIPTION EXAMPLE

THZ	—	632	—	150	—	SS
T		T		T		T
Series Code		Insert Thread Code		Insert Length Code		Material Code ¹

(1) SS material code designates stainless steel. Standard insert material is brass. Omit SS material code for brass inserts. Custom materials and finishes available by request.

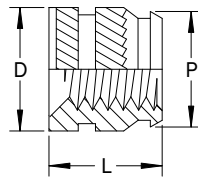

Insert Series Code THZ (Single Barb)

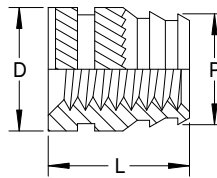

Insert Series Code THZ (Double Barb)

THZ Tapered Hole Zerts

GENERAL

	Insert Thread	Insert Thread Code	L Insert Length	L Insert Length Code	Barb Style	Boss			D Insert Diameter	P Pilot Diameter
						B Hole Dia. ±.001	T Hole Dia. ±.001	W Wall Thickness Min.		
INCH	0-80	080	.115	115	Single	.118	.123	.080	.136	.122
			.188	188	Double	.107				.115
	2-56	256	.115	115	Single	.118	.123	.080	.136	.122
			.188	188	Double	.107				.115
	4-40	440	.135	135	Single	.153	.159	.093	.172	.157
			.219	219	Double	.141				.144
	6-32	632	.150	150	Single	.199	.206	.116	.220	.203
			.250	250	Double	.185				.190
	8-32	832	.185	185	Single	.226	.234	.133	.250	.230
			.312	312	Double	.208				.212
	10-24	1024	.225	225	Single	.267	.277	.159	.296	.272
			.375	375	Double	.246				.251
	10-32	1032	.225	225	Single	.267	.277	.159	.296	.272
			.375	375	Double	.246				.251
	1/4-20	2520	.300	300	Single	.349	.363	.194	.375	.354
			.500	500	Double	.321				.332
	1/4-28	2528	.300	300	Single	.349	.363	.194	.375	.354
			.500	500	Double	.321				.332
	5/16-18	3118	.335	335	Single	.431	.448	.245	.469	.439
			.562	562	Double	.401				.406
5/16-24	3124	.335	335	Single	.431	.448	.245	.469	.439	
		.562	562	Double	.401				.406	
3/8-16	3716	.375	375	Single	.523	.540	.293	.563	.530	
		.625	625	Double	.488				.493	
3/8-24	3724	.375	375	Single	.523	.540	.293	.563	.530	
		.625	625	Double	.488				.493	

(1) All dimensions are in inches and reference unless toleranced.

THZ Tapered Hole Zerts

GENERAL (CONTINUED)

	Insert Thread	Insert Thread Code	L Insert Length	L Insert Length Code	Barb Style	Boss			D Insert Diameter	P Pilot Diameter
						B Hole Dia. ±0.025	T Hole Dia. ±0.025	W Wall Thickness Min.		
METRIC	M1 x 0.25	M1	2.90	2.90	Single	3.00	3.12	2.00	3.45	3.10
			4.80	4.80	Double	2.72				2.92
	M2 x 0.4	M2	2.90	2.90	Single	3.00	3.12	2.00	3.45	3.10
			4.80	4.80	Double	2.72				2.92
	M2.5 x 0.45	M2.5	3.40	3.40	Single	3.88	4.04	2.40	4.37	3.98
			5.60	5.60	Double	3.58				3.66
	M3 x 0.5	2.5M3	3.43	3.43	Single	3.89	4.04	2.40	4.37	3.99
			5.56	5.56	Double	3.58				3.78
	M3 x 0.5	M3	3.80	3.80	Single	5.05	5.23	3.00	5.59	5.15
			6.40	6.40	Double	4.70				4.82
	M3.5 x 0.6	M3.5	3.80	3.80	Single	5.05	5.23	3.00	5.59	5.15
			6.40	6.40	Double	4.70				4.82
	M4 x 0.7	M4	4.70	4.70	Single	5.74	5.94	3.40	6.35	5.84
			7.90	7.90	Double	5.28				5.38
	M5 x 0.8	M5	6.70	6.70	Single	7.69	8.00	4.40	8.33	7.82
			11.10	11.10	Double	7.06				7.19
	M6 x 1.0	M6	7.60	7.60	Single	8.86	9.22	4.90	9.53	8.99
			12.70	12.70	Double	8.15				8.43
M8 x 1.25	M8	8.50	8.50	Single	10.95	11.38	6.20	11.90	11.15	
		14.30	14.30	Double	10.18				10.31	
M10 x 1.5	M10	9.50	9.50	Single	13.28	13.71	7.50	14.30	13.46	
		15.90	15.90	Double	12.39				12.52	

(1) All dimensions are in millimeters and reference unless tolerated.

BOSS DESIGN RECOMMENDATION

The THZ Tapered Hole Zert is designed to be installed into a molded hole with a 8° inclusive taper for approximately 1/3 to 2/3 of its length and straight for the remainder. The top of the hole should not be countersunk or counterbored as this will decrease the insert's performance. The recommended hole size applies at the point reached by the bottom of the insert. Molded holes should be used wherever possible as drilled holes may result in diminished performance. Minimum boss wall thicknesses shown are for reference and may vary depending on the type of plastic.

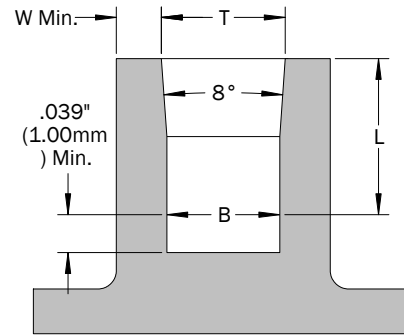

INSTALLATION

The inserts may be installed by pre-heating or ultrasonic vibration methods. When using heat, the insert should be hot enough to soften the plastic without melting it to avoid flash around the top. Ultrasonic vibration should be applied using low amplitude and the minimum amount of power necessary to satisfactorily soften the plastic. In both methods, avoid excessive pressure that would force an insert into a hole without allowing the plastic to properly soften and flow around the insert features.

PERFORMANCE

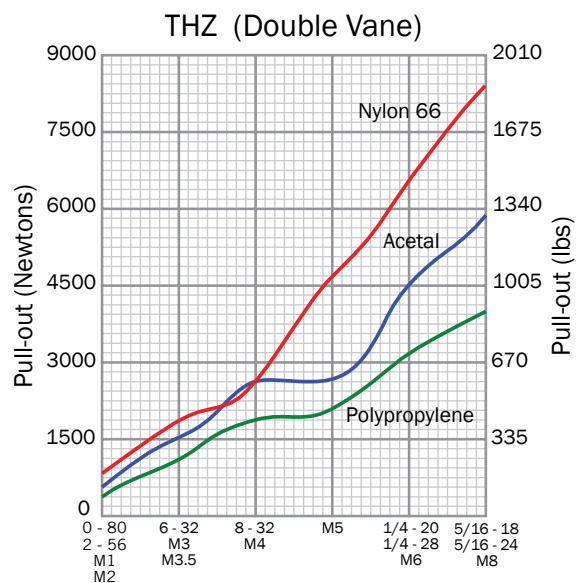

(1) Performance data shown is for reference only. Variations in application, boss material type and size, and installation method will affect the loads. PENCOM strongly encourages testing in the application.

THZ Tapered Hole Zerts



TWZ

Twin Zerts

FEATURES

- Self-aligning installation using heat.
- Opposing helical knurls and knurled vanes provide superior pull-out and torque-out resistance.
- Double-ended to assist automatic feeding by eliminating the need for orientation during installation.
- Thin boss walls permit compact design.
- Available in a wide variety of thread sizes, stud lengths and options.



PART DESCRIPTION EXAMPLE

TWZS — 632 — 279 X 375 — SS
 T T T T T
 Series Code Insert or Stud Thread Code Insert Length Code Stud Length Code¹ Material Code²

- (1) Omit stud length code for non-studded inserts.
 (2) SS material code designates stainless steel. Standard insert material is brass. Omit SS material code for brass inserts. Custom materials and finishes available by request.

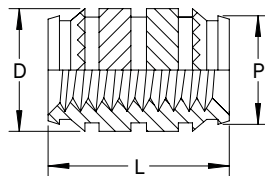

Insert
Series Code TWZ

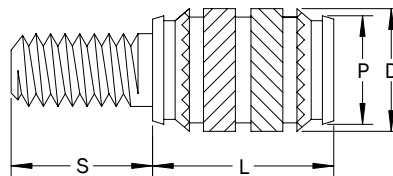

Insert w/ Stud
Series Code TWZS

TWZ Twin Zerts

GENERAL

	Insert Thread	Insert Thread Code	Boss		D Insert Diameter	P Pilot Diameter
			B Hole Dia. +.004 -.000	W Wall Thickness Min.		
INCH	2-56	256	.125	.051	.137	.123
	4-40	440	.157	.063	.174	.154
	6-32	632	.189	.071	.205	.185
	8-32	832	.220	.083	.239	.218
	10-24	1024	.252	.102	.269	.249
	10-32	1032	.252	.102	.269	.249
	1/4-20	2520	.315	.130	.333	.312
	1/4-28	2528	.315	.130	.333	.312
	5/16-18	3118	.378	.177	.394	.374
	5/16-24	3124	.378	.177	.394	.374
	3/8-16	3716	.469	.236	.485	.465
	3/8-24	3724	.469	.236	.485	.465
	1/2-13	5013	.630	.315	.643	.622
	1/2-20	5020	.630	.315	.643	.622

(1) All dimensions are in inches and reference unless toleranced.

	Insert Thread	Insert Thread Code	Boss		D Insert Diameter	P Pilot Diameter
			B Hole Dia. +0.10 - 0.00	W Wall Thickness Min.		
METRIC	M2 x 0.4	M2	3.20	1.30	3.50	3.10
	M2.5 x 0.45	M2.5	4.00	1.60	4.40	3.90
	M3 x 0.5	M3	4.00	1.60	4.40	3.90
	M3.5 x 0.6	M3.5	4.80	1.80	5.20	4.70
	M4 x 0.7	M4	5.60	2.10	6.10	5.50
	M5 x 0.8	M5	6.40	2.60	6.80	6.30
	M6 x 1.0	M6	8.00	3.30	8.50	7.90
	M8 x 1.25	M8	9.60	4.50	10.00	9.50
	M10 x 1.5	M10	11.90	6.00	12.30	11.80
	M12 x 1.75	M12	16.00	8.00	16.30	15.80

(1) All dimensions are in millimeters and reference unless toleranced.

INSERT LENGTH

INCH	Insert Thread	L Insert Length	Insert Length Code
	2-56	.118	118
		.155 ²	155
	4-40	.157	157
		.188	188
		.224 ²	224
	6-32	.197	197
		.279 ²	279
	8-32	.157	157
		.188	188
		.228	228
		.319 ²	319
	10-24	.228	228
	10-32	.373 ²	373
	1/4-20 1/4-28	.269	269
.374		374	
.498 ²		498	
5/16-18 5/16-24	.498 ²	498	
3/8-16 3/8-24	.498 ²	498	
1/2-13 1/2-20	.626 ²	626	

- (1) All dimensions are in inches and reference unless toleranced.
- (2) Preferred insert length.
- (3) Custom insert lengths available by request.

METRIC	Insert Thread	L Insert Length	Insert Length Code
	M2 x 0.4	3.00	3.00
		3.94 ²	3.94
	M2.5 x 0.45	4.00	4.00
		5.69 ²	5.69
	M3 x 0.5	4.00	4.00
		4.80	4.80
		5.69 ²	5.69
	M3.5 x 0.6	5.00	5.00
		7.09 ²	7.09
	M4 x 0.7	4.00	4.00
		4.80	4.80
		8.10 ²	8.10
	M5 x 0.8	5.80	5.80
		9.47 ²	9.47
	M6 x 1.0	6.80	6.80
		9.50	9.50
		12.65 ²	12.65
M8 x 1.25	12.65 ²	12.65	
M10 x 1.5	12.65 ²	12.65	
M12 x 1.75	15.88 ²	15.88	

- (1) All dimensions are in millimeters and reference unless toleranced.
- (2) Preferred insert length.
- (3) Custom insert lengths available by request.

STUD LENGTH (CONTINUED)

	Stud Thread	Stud Thread Code	D Insert Diameter	S - Stud Length									
				.187	.250	.312	.375	.437	.500	.625	.750	.875	1.000
				Stud Length Code									
INCH	2-56	256	.137	187	250	312	—	—	—	—	—	—	—
	4-40	440	.174	187	250	312	375	437	—	—	—	—	—
	6-32	632	.205	187	250	312	375	437	500	—	—	—	—
	8-32	832	.239	187	250	312	375	437	500	625	—	—	—
	10-24	1024	.269	187	250	312	375	437	500	625	750	—	—
	10-32	1032	.269	187	250	312	375	437	500	625	750	—	—
	1/4-20	2520	.333	—	250	312	375	437	500	625	750	875	1000
	1/4-28	2528	.333	—	250	312	375	437	500	625	750	875	1000
	5/16-18	3118	.394	—	—	312	375	437	500	625	750	875	1000
	5/16-24	3124	.394	—	—	312	375	437	500	625	750	875	1000
	3/8-16	3716	.485	—	—	—	375	437	500	625	750	875	1000
	3/8-24	3724	.485	—	—	—	375	437	500	625	750	875	1000
	1/2-13	5013	.643	—	—	—	—	—	500	625	750	875	1000
	1/2-20	5020	.643	—	—	—	—	—	500	625	750	875	1000

- (1) All dimensions are in inches and reference unless toleranced.
- (2) Custom stud lengths available by request.

STUD LENGTH (CONTINUED)

METRIC	Stud Thread	Stud Thread Code	D Insert Diameter	S - Stud Length									
				5.00	6.00	8.00	10.00	12.00	14.00	16.00	18.00	20.00	25.00
				Stud Length Code									
M2 x 0.4	M2	3.50	5.00	6.00	8.00	—	—	—	—	—	—	—	
M2.5 x 0.45	M2.5	4.40	5.00	6.00	8.00	10.00	—	—	—	—	—	—	
M3 x 0.5	M3	4.40	5.00	6.00	8.00	10.00	12.00	—	—	—	—	—	
M3.5 x 0.6	M3.5	5.20	5.00	6.00	8.00	10.00	12.00	14.00	—	—	—	—	
M4 x 0.7	M4	6.10	5.00	6.00	8.00	10.00	12.00	14.00	16.00	—	—	—	
M5 x 0.8	M5	6.80	5.00	6.00	8.00	10.00	12.00	14.00	16.00	18.00	20.00	—	
M6 x 1.0	M6	8.50	—	6.00	8.00	10.00	12.00	14.00	16.00	18.00	20.00	25.00	
M8 x 1.25	M8	10.00	—	—	8.00	10.00	12.00	14.00	16.00	18.00	20.00	25.00	
M10 x 1.5	M10	12.30	—	—	—	10.00	12.00	14.00	16.00	18.00	20.00	25.00	
M12 x 1.75	M12	16.30	—	—	—	—	12.00	14.00	16.00	18.00	20.00	25.00	

- (1) All dimensions are in millimeters and reference unless toleranced.
- (2) Custom stud lengths available by request.

BOSS DESIGN RECOMMENDATION

The TWZ Twin Zert is designed to be installed into a straight molded hole with a 0.5° inclusive taper. The top of the hole should not be countersunk or counterbored as this will decrease the insert's performance. The recommended hole size applies at the point reached by the bottom of the insert. Molded holes should be used wherever possible as drilled holes may result in diminished performance. Minimum boss wall thicknesses shown are for reference and may vary depending on the type of plastic.

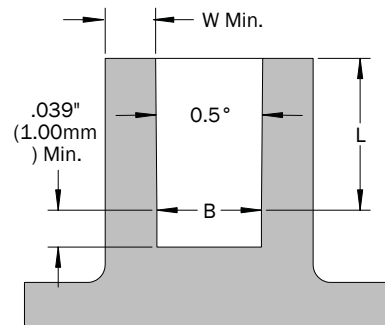

INSTALLATION

Pre-heating is the recommended installation method. The insert should be hot enough to soften the plastic without melting it to avoid flash around the top. Avoid excessive pressure that would force an insert into a hole without allowing the plastic to properly soften and flow around the insert features.

PERFORMANCE

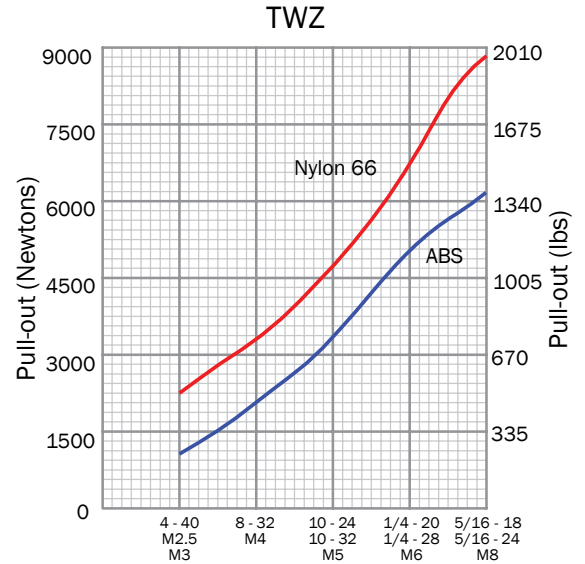

(1) Performance data shown is for preferred insert lengths and reference only. Variations in application, boss material type and size, and installation method will affect the loads. PENCOM strongly encourages testing in the application.



MNZ

Miniature Zerts

FEATURES

- Similar characteristics as the TWZ Twin Zert in a miniature design.
- Rapid self-aligning installation using heat.
- Small size permits space-saving boss design.
- Double-ended to assist automatic feeding by eliminating the need for orientation during installation.



PART DESCRIPTION EXAMPLE

MNZ	—	M1.4	—	3.00	—	SS
┆		┆		┆		┆
Series Code		Insert Thread Code		Insert Length Code		Material Code ¹

(1) SS material code designates stainless steel. Standard insert material is brass. Omit SS material code for brass inserts. Custom materials and finishes available by request.

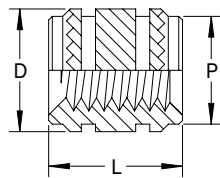

Insert
Series Code MNZ

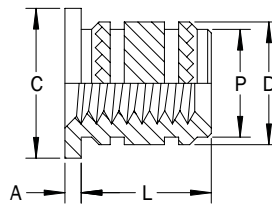

Headed Insert
Series Code MNZH

GENERAL

METRIC	Insert Thread	Insert Thread Code	Boss		A Head Thickness	C Head Diameter	D Insert Diameter	P Pilot Diameter
			B Hole Dia. +0.10 - 0.00	W Wall Thickness Min.				
	M1 x 0.25	M1	1.75	0.70	—	—	2.10	1.70
	M1.2 x 0.25	M1.2	1.75	0.70	—	—	2.10	1.70
	M1.4 x 0.3	M1.4	2.15	0.80	0.40	3.00	2.50	2.10
	M1.6 x 0.35	M1.6	2.15	0.80	0.40	3.00	2.50	2.10
	M2 x 0.4	M2	2.65	0.80	0.40	3.50	3.00	2.60
	M2.5 x 0.45	M2.5	3.20	1.00	0.40	4.00	3.65	3.15

(1) All dimensions are in millimeters and reference unless toleranced.

INSERT LENGTH

METRIC	Insert Thread	L Insert Length	Insert Length Code
	M1	2.50	2.50
	M1.2	2.50	2.50
	M1.4	3.00	3.00
	M1.6	2.00	2.00
		2.20	2.20
		2.50	2.50
		3.00	3.00
	M2	3.00	3.00
	M2.5	4.00	4.00

- (1) All dimensions are in millimeters and reference unless toleranced.
 (2) Custom insert lengths available by request.

BOSS DESIGN RECOMMENDATION

The MNZ Miniature Zert is designed to be installed into a straight hole with a 0.5° inclusive taper. The top of the hole should not be countersunk or counterbored as this will decrease the insert's performance. The recommended hole size applies at the point reached by the bottom of the insert. Molded holes should be used wherever possible as drilled holes may result in diminished performance. Minimum boss wall thicknesses shown are for reference and may vary depending on the type of plastic.

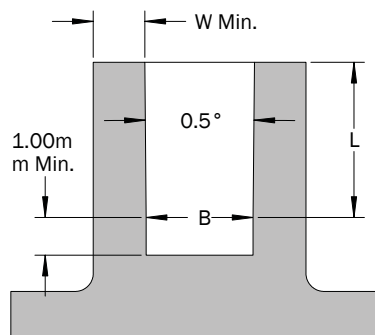

INSTALLATION

Pre-heating is the recommended installation method. The insert should be hot enough to soften the plastic without melting it to avoid flash around the top. Avoid excessive pressure that would force an insert into a hole without allowing the plastic to properly soften and flow around the insert features.



LSZ

Low Stress Zerts

FEATURES

- Rounded knurl pattern reduces stress in notch sensitive amorphous thermoplastics.
- Rapid self-aligning installation using heat.
- Double-ended to assist automatic feeding by eliminating the need for orientation during installation.
- Knurl pattern provides high torque-out resistance.
- Available in a wide variety of thread sizes, stud lengths and options.



PART DESCRIPTION EXAMPLE

LSZS — 632 — 281 X 375 — SS
 T T T X T T T T T
 Series Code Insert or Stud Thread Code Insert Length Code Stud Length Code¹ Material Code²

(1) Omit stud length code for non-studded inserts.

(2) SS material code designates stainless steel. Standard insert material is brass. Omit SS material code for brass inserts. Custom materials and finishes available by request.

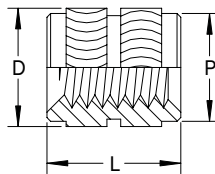

Insert
Series Code LSZ

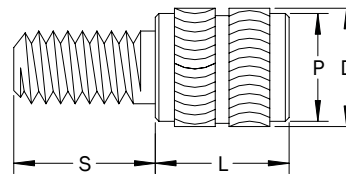

Insert w/ Stud
Series Code LSZS

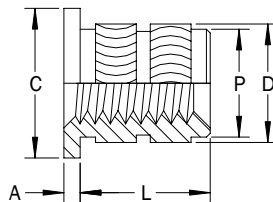

Headed Insert
Series Code LSZH

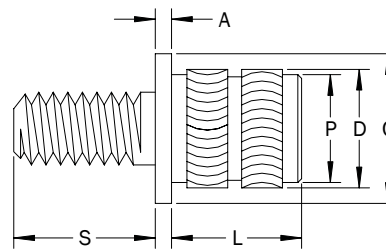

Headed Insert w/ Stud
Series Code LSZHS

LSZ Low Stress Zerts

GENERAL

INCH	Insert Thread	Insert Thread Code	L Insert Length	Insert Length Code	Boss		A Head Thickness	C Head Diameter	D Insert Diameter	P Pilot Diameter
					B Hole Dia. +.004 -.000	W Minimum Wall Thickness				
	2-56	256	.155	155	.126	.055	.020	.187	.137	.123
	4-40	440	.228	228	.157	.071	.023	.217	.174	.154
	6-32	632	.281	281	.189	.083	.029	.250	.206	.185
	8-32	832	.320	320	.220	.094	.035	.280	.239	.218
	10-24	1024	.374	374	.252	.110	.042	.312	.270	.249
	10-32	1032	.374	374	.252	.110	.042	.312	.270	.249
	1/4-20	2520	.500	500	.315	.142	.052	.375	.333	.312
	1/4-28	2528	.500	500	.315	.142	.052	.375	.333	.312
	5/16-18	3118	.500	500	.378	.197	.052	.437	.393	.375
	5/16-24	3124	.500	500	.378	.197	.052	.437	.393	.375

(1) All dimensions are in inches and reference unless toleranced.

METRIC	Insert Thread	Insert Thread Code	L Insert Length	Insert Length Code	Boss		A Head Thickness	C Head Diameter	D Insert Diameter	P Pilot Diameter
					B Hole Dia. +0.10 - 0.00	W Minimum Wall Thickness				
	M2 x 0.4	M2	3.90	3.90	3.20	1.40	0.51	4.80	3.50	3.10
	M2.5 x 0.45	M2.5	5.80	5.80	4.00	1.80	0.58	5.50	4.40	3.90
	M3 x 0.5	M3	5.80	5.80	4.00	1.80	0.58	5.50	4.40	3.90
	M3.5 x 0.6	M3.5	7.10	7.10	4.80	2.10	0.74	6.40	5.20	4.70
	M4 x 0.7	M4	8.10	8.10	5.60	2.40	0.89	7.10	6.10	5.50
	M5 x 0.8	M5	9.50	9.50	6.40	2.80	1.07	7.90	6.90	6.30
	M6 x 1.0	M6	12.70	12.70	8.00	3.60	1.32	9.50	8.50	7.90
	M8 x 1.25	M8	12.70	12.70	9.60	5.00	1.32	11.10	10.00	9.50

(1) All dimensions are in millimeters and reference unless toleranced.

STUD LENGTH

INCH	Stud Thread	Stud Thread Code	D Insert Diameter	S - Stud Length									
				.187	.250	.312	.375	.437	.500	.625	.750	.875	1.000
				Stud Length Code									
	2-56	256	.137	187	250	312	—	—	—	—	—	—	—
	4-40	440	.174	187	250	312	375	437	—	—	—	—	—
	6-32	632	.206	187	250	312	375	437	500	—	—	—	—
	8-32	832	.239	187	250	312	375	437	500	625	—	—	—
	10-24	1024	.270	187	250	312	375	437	500	625	750	—	—
	10-32	1032	.270	187	250	312	375	437	500	625	750	—	—
	1/4-20	2520	.333	—	250	312	375	437	500	625	750	875	1000
	1/4-28	2528	.333	—	250	312	375	437	500	625	750	875	1000
	5/16-18	3118	.393	—	—	312	375	437	500	625	750	875	1000
	5/16-24	3124	.393	—	—	312	375	437	500	625	750	875	1000

- (1) All dimensions are in inches and reference unless toleranced.
- (2) Custom stud lengths available by request.

METRIC	Stud Thread	Stud Thread Code	D Insert Diameter	S - Stud Length									
				5.00	6.00	8.00	10.00	12.00	14.00	16.00	18.00	20.00	25.00
				Stud Length Code									
	M2 x 0.4	M2	3.50	5.00	6.00	8.00	—	—	—	—	—	—	—
	M2.5 x 0.45	M2.5	4.40	5.00	6.00	8.00	10.00	—	—	—	—	—	—
	M3 x 0.5	M3	4.40	5.00	6.00	8.00	10.00	12.00	—	—	—	—	—
	M3.5 x 0.6	M3.5	5.20	5.00	6.00	8.00	10.00	12.00	14.00	—	—	—	—
	M4 x 0.7	M4	6.10	5.00	6.00	8.00	10.00	12.00	14.00	16.00	—	—	—
	M5 x 0.8	M5	6.90	5.00	6.00	8.00	10.00	12.00	14.00	16.00	18.00	20.00	—
	M6 x 1.0	M6	8.50	—	6.00	8.00	10.00	12.00	14.00	16.00	18.00	20.00	25.00
	M8 x 1.25	M8	10.00	—	—	8.00	10.00	12.00	14.00	16.00	18.00	20.00	25.00

- (1) All dimensions are in millimeters and reference unless toleranced.
- (2) Custom stud lengths available by request.

BOSS DESIGN RECOMMENDATION

The LSZ Low Stress Zert is designed to be installed into a straight hole with a 0.5° inclusive taper. The top of the hole should not be countersunk or counterbored as this will decrease the insert's performance. The recommended hole size applies at the point reached by the bottom of the insert. Molded holes should be used wherever possible as drilled holes may result in diminished performance. Minimum boss wall thicknesses shown are for reference and may vary depending on the type of plastic.

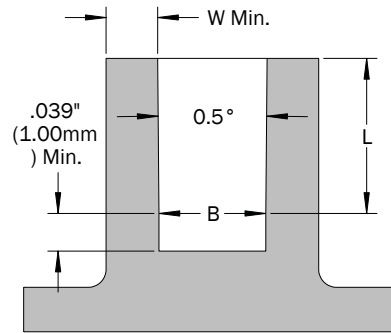

INSTALLATION

Pre-heating is the recommended installation method. The insert should be hot enough to soften the plastic without melting it to avoid flash around the top. Avoid excessive pressure that would force an insert into a hole without allowing the plastic to properly soften and flow around the insert features.

PERFORMANCE

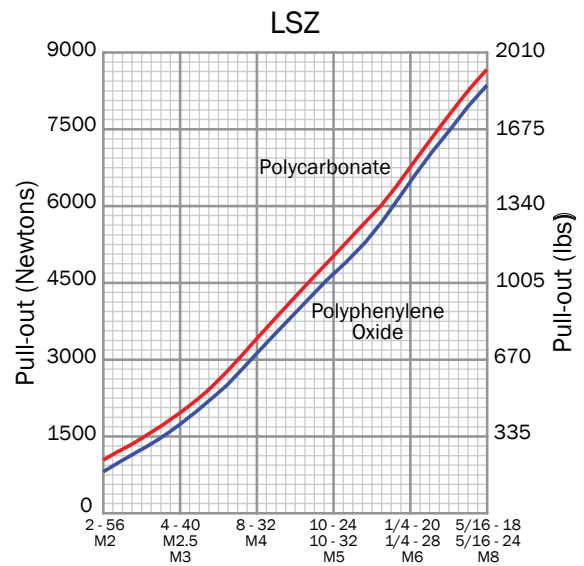

(1) Performance data shown is for reference only. Variations in application, boss material type and size, and installation method will affect the loads. PENCOM strongly encourages testing in the application.

LSZ Low Stress Zerts



HCZ

Hi-Capacity Zerts

FEATURES

- Excellent pull-out and torque-out performance capable of exceeding the strength of most male fasteners.
- Unique design improves installation speed and process capability leading to higher productivity and reduced scrap.
- Available with both inch and metric threads.



PART DESCRIPTION EXAMPLE

HCZ	—	832	—	378	—	SS
┆		┆		┆		┆
Series Code		Insert Thread Code		Insert Length Code		Material Code ¹

(1) SS material code designates stainless steel. Standard insert material is brass. Omit SS material code for brass inserts. Custom materials and finishes available by request.

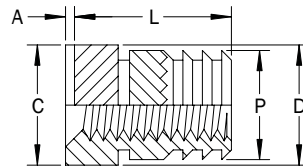

**Insert
Series Code HCZ**

HCZ Hi-Capacity Zerts

GENERAL

	Insert Thread	Insert Thread Code	L Insert Length	Insert Length Code	Boss						
					a Min.	b Ref.	c +.004 -.000	d +.004 -.000	e +.004 -.000	f +.004 -.000	g +.004 -.000
INCH	8-32	832	.378	378	.433	.378	.035	.394	.327	.256	.291
	10-24	1024	.433	433	.472	.433	.035	.449	.390	.256	.339
	10-32	1032	.433	433	.472	.433	.035	.449	.390	.256	.339
	1/4-20	2520	.433	433	.472	.433	.035	.512	.445	.256	.409
	1/4-28	2528	.433	433	.472	.433	.035	.512	.445	.256	.409
	5/16-18	3118	.433	433	.472	.433	.035	.551	.512	.256	.476
	5/16-24	3124	.433	433	.472	.433	.035	.551	.512	.256	.476
	3/8-16	3716	.433	433	.472	.433	.035	.630	.575	.256	.539
3/8-24	3724	.433	433	.472	.433	.035	.630	.575	.256	.539	

(1) All dimensions are in inches and reference unless tolerated.

	Insert Thread	Insert Thread Code	L Insert Length	Insert Length Code	Boss						
					a Min.	b Ref.	c +0.10 -0.00	d +0.10 -0.00	e +0.10 -0.00	f +0.10 -0.00	g +0.10 -0.00
METRIC	M4 x 0.7	M4	9.60	9.60	11.00	9.60	0.90	10.00	8.30	6.50	7.40
	M5 x 0.8	M5	11.00	11.00	12.00	11.00	0.90	11.40	9.90	6.50	8.60
	M6 x 1.0	M6	11.00	11.00	12.00	11.00	0.90	13.00	11.30	6.50	10.40
	M8 x 1.25	M8	11.00	11.00	12.00	11.00	0.90	14.00	13.00	6.50	12.10
	M10 x 1.5	M10	11.00	11.00	12.00	11.00	0.90	16.00	14.60	6.50	13.70

(1) All dimensions are in millimeters and reference unless tolerated.

GENERAL (CONTINUED)

INCH	Thread Code	w Boss Wall Thickness Min.	A Head Thickness	C Head Diameter	D Insert Diameter	P Pilot Diameter
	832	.138	.020	.354	.354	.323
	1024	.177	.020	.413	.413	.382
	1032	.177	.020	.413	.413	.382
	2520	.236	.020	.472	.472	.441
	2528	.236	.020	.472	.472	.441
	3118	.315	.020	.539	.539	.508
	3124	.315	.020	.539	.539	.508
	3716	.394	.020	.598	.598	.571
3724	.394	.020	.598	.598	.571	

(1) All dimensions are in inches and reference unless toleranced.

METRIC	Thread Code	w Boss Wall Thickness Min.	A Head Thickness	C Head Diameter	D Insert Diameter	P Pilot Diameter
	M4	3.50	0.50	9.00	9.00	8.20
	M5	4.50	0.50	10.50	10.50	9.70
	M6	6.00	0.50	12.00	12.00	11.20
	M8	8.00	0.50	13.70	13.70	12.90
	M10	10.00	0.50	15.20	15.20	14.50

(1) All dimensions are in millimeters and reference unless toleranced.

BOSS DESIGN RECOMMENDATION

The HCZ Hi-Capacity Zert is designed to be installed into a specifically shaped molded hole. Minimum boss wall thickness shown are for reference and may vary depending on the type of plastic.

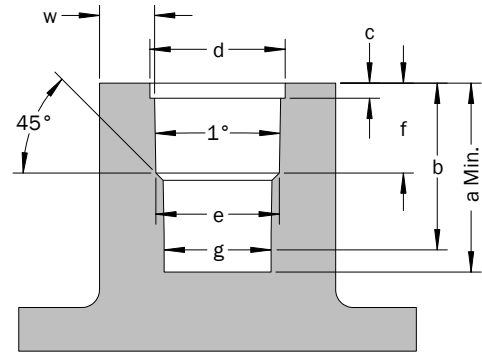

INSTALLATION

The inserts may be installed by pre-heating or ultrasonic vibration methods. When using heat, the insert should be hot enough to soften the plastic without melting it to avoid flash around the top. Ultrasonic vibration should be applied using low amplitude and the minimum amount of power necessary to satisfactorily soften the plastic. In both methods, avoid excessive pressure that would force an insert into a hole without allowing the plastic to properly soften and flow around the insert features. To achieve maximum performance, install the insert flush with the top of the hole.

PERFORMANCE

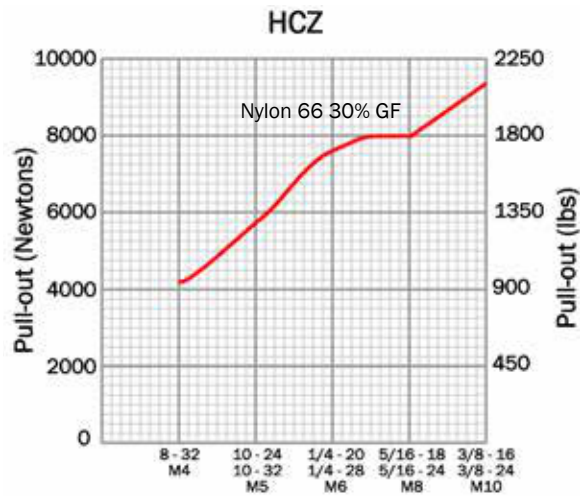

(1) Performance data shown is for reference only. Variations in application, boss material type and size, and installation method will affect the loads. PENCOM strongly encourages testing in the application.

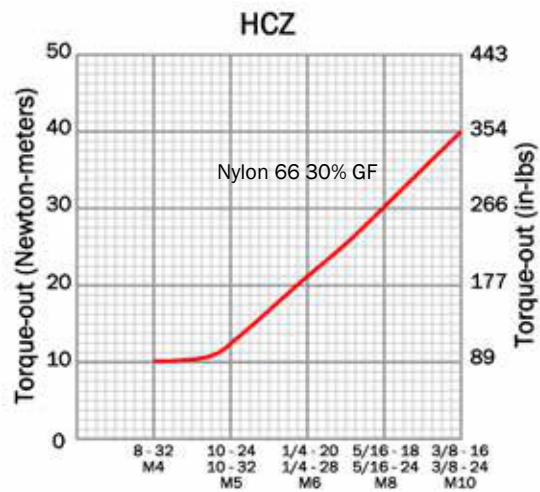

(1) Performance data shown is for reference only. Variations in application, boss material type and size, and installation method will affect the loads. PENCOM strongly encourages testing in the application.

HCZ Hi-Capacity Zerts



EDZ

Expansion Diamond Zerts

FEATURES

- Simple press-in installation for most thermoplastics.
- Mating screw resistant to loosening after installation.
- Reverse-headed style provides excellent jack-out resistance.



PART DESCRIPTION EXAMPLE

EDZ	—	632	—	249
T		T		T
Series Code		Insert Thread Code		Insert Length Code

Standard material is brass. Custom materials and finishes available by request.

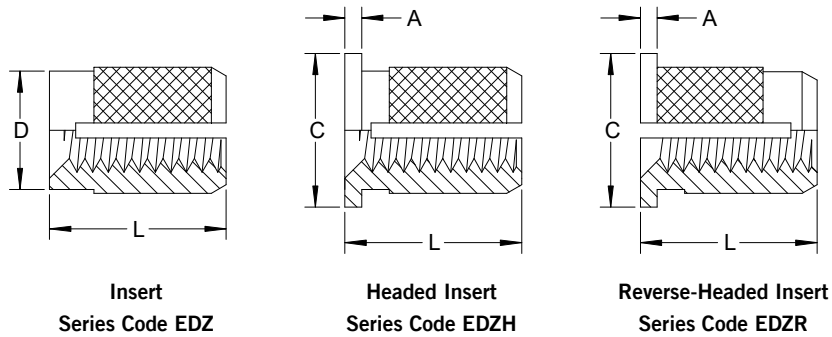

(Install Screw from Unslotted End)

EDZ Expansion Diamond Zerts

GENERAL

	Insert Thread	Insert Thread Code	Boss		A Head Thickness	C Head Diameter	D Insert Diameter
			B Hole Dia. +.004 -.000	W Wall Thickness Min.			
INCH	2-56	256	.126	.094	.017	.187	.124
	4-40	440	.157	.126	.020	.218	.156
	6-32	632	.189	.142	.026	.250	.186
	8-32	832	.220	.157	.032	.281	.217
	10-24	1024	.252	.189	.039	.312	.249
	10-32	1032	.252	.189	.039	.312	.249
	1/4-20	2520	.315	.236	.049	.375	.311
	1/4-28	2528	.315	.236	.049	.375	.311
	5/16-18	3118	.378	.276	.049	.437	.374
	5/16-24	3124	.378	.276	.049	.437	.374

(1) All dimensions are in inches and reference unless tolerated.

	Insert Thread	Insert Thread Code	Boss		A Head Thickness	C Head Diameter	D Insert Diameter
			B Hole Dia. +0.10 - 0.00	W Wall Thickness Min.			
METRIC	M2 x 0.4	M2	3.20	2.40	0.43	4.80	3.20
	M2.5 x 0.45	M2.5	4.00	3.20	0.51	5.50	4.00
	M3 x 0.5	M3	4.00	3.20	0.51	5.50	4.00
	M3.5 x 0.6	M3.5	4.80	3.60	0.66	6.40	4.70
	M4 x 0.7	M4	5.60	4.00	0.82	7.10	5.50
	M5 x 0.8	M5	6.40	4.80	0.99	7.90	6.30
	M6 x 1.0	M6	8.00	6.00	1.25	9.50	7.90
	M8 x 1.25	M8	9.60	7.00	1.25	11.10	9.50

(1) All dimensions are in millimeters and reference unless tolerated.

INSERT LENGTH

INCH	Insert Thread	L Insert Length	Insert Length Code
	2-56	.155 ²	155
	4-40	.138	138
		.186 ²	186
	6-32	.138	138
		.249 ²	249
	8-32	.197	197
		.312 ²	312
	10-24 10-32	.236	236
		.371 ²	371
1/4-20 1/4-28	.374	374	
	.497 ²	497	
5/16-18 5/16-24	.374	374	
	.497 ²	497	

- (1) All dimensions are in inches and reference unless toleranced.
- (2) Preferred length.
- (3) Custom insert lengths available by request.

METRIC	Insert Thread	L Insert Length	Insert Length Code
	M2 x 0.4	3.90 ²	3.90
	M2.5 x 0.45	4.70 ²	4.70
	M3 x 0.5	3.50	3.50
		4.70 ²	4.70
	M3.5 x 0.6	3.50	3.50
		6.30 ²	6.30
	M4 x 0.7	5.00	5.00
		7.90 ²	7.90
	M5 x 0.8	6.00	6.00
		9.40 ²	9.40
	M6 x 1.0	9.50	9.50
		12.60 ²	12.60
	M8 x 1.25	9.50	9.50
		12.60 ²	12.60

- (1) All dimensions are in millimeters and reference unless toleranced.
- (2) Preferred length.
- (3) Custom insert lengths available by request.

BOSS DESIGN RECOMMENDATION

The EDZ Expansion Diamond Zert is designed to be installed into a straight hole with a 1° inclusive taper. The top of the hole should not be countersunk or counterbored as this will decrease the insert’s performance. The recommended hole size applies at the point reached by the bottom of the insert. Molded holes should be used wherever possible as drilled holes may result in diminished performance. Minimum boss wall thicknesses shown are for reference and may vary depending on the type of plastic.

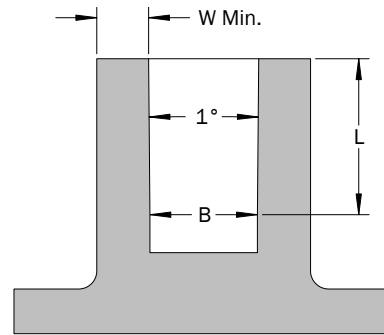

INSTALLATION

Press the insert into the boss using a squeezing action never a hammer blow. Ensure that the insert maintains axial alignment during installation to prevent tilting which will induce side loads on the boss. Oversize boss holes weaken the insert’s self-aligning characteristics causing side loads which may lead to possible boss cracking. Install a fixing screw with sufficient length to fully penetrate the insert and achieve maximum expansion prior to applying full clamping load. The EDZR Reverse-headed Insert should be mounted with the head on the back of the molding.

PERFORMANCE

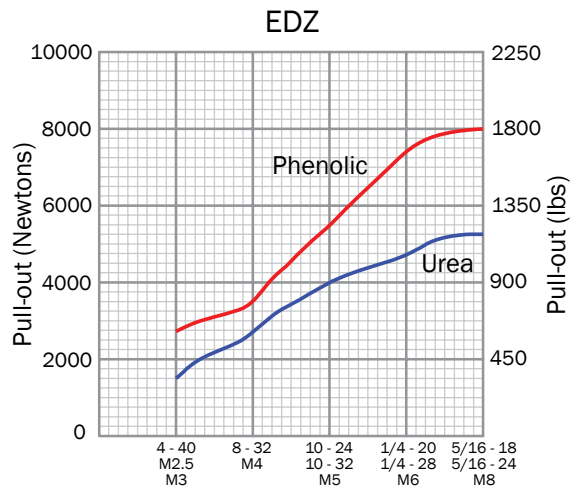

(1) Performance data shown is for preferred insert lengths and reference only. Variations in application, boss material type and size, and installation method will affect the loads. PENCOM strongly encourages testing in the application.



EFZ

Expansion Fin Zerts

FEATURES

- Simple press-in installation for most thermoplastics.
- Mating screw resistant to loosening after installation.
- High pull-out and torque-out resistance.



PART DESCRIPTION EXAMPLE

EFZ	—	632	—	283
T		T		T
Series Code		Insert Thread Code		Insert Length Code

Standard material is brass. Custom materials and finishes available by request.

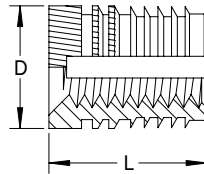

Insert
Series Code EFZ

EFZ Expansion Fin Zerts

GENERAL

INCH	Insert Thread	Insert Thread Code	Boss		D Insert Diameter
			B Hole Dia. +.004 -.000	W Wall Thickness Min.	
	2-56	256	.126	.063	.146
	4-40	440	.157	.079	.177
	6-32	632	.189	.094	.209
	8-32	832	.220	.110	.242
	10-24	1024	.252	.126	.272
	10-32	1032	.252	.126	.272
	1/4-20	2520	.315	.157	.335
	1/4-28	2528	.315	.157	.335
	5/16-18	3118	.378	.189	.398
	5/16-24	3124	.378	.189	.398

(1) All dimensions are in inches and reference unless toleranced.

METRIC	Insert Thread	Insert Thread Code	Boss		D Insert Diameter
			B Hole Dia. +0.10 - 0.00	W Wall Thickness Min.	
	M2 x 0.4	M2	3.20	1.60	3.70
	M2.5 x 0.45	M2.5	4.00	2.00	4.50
	M3 x 0.5	M3	4.00	2.00	4.50
	M3.5 x 0.6	M3.5	4.80	2.40	5.30
	M4 x 0.7	M4	5.60	2.80	6.20
	M5 x 0.8	M5	6.40	3.20	6.90
	M6 x 1.0	M6	8.00	4.00	8.50
	M8 x 1.25	M8	9.60	4.80	10.10

(1) All dimensions are in millimeters and reference unless toleranced.

INSERT LENGTH

INCH	Insert Thread	L Insert Length	Insert Length Code
	4-40	.157	157
		.228 ²	228
	6-32	.157	157
		.283 ²	283
	8-32	.228	228
		.323 ²	323
	10-24 10-32	.228	228
		.322	322
		.374 ²	374
	1/4-20 1/4-28	.283	283
		.374	374
		.500 ²	500
	5/16-18 5/16-24	.500 ²	500

- (1) All dimensions are in inches and reference unless toleranced.
- (2) Preferred length.
- (3) Custom insert lengths available by request.

METRIC	Insert Thread	L Insert Length	Insert Length Code
	M2.5 x 0.45	4.00	4.00
		5.80 ²	5.80
	M3 x 0.5	4.00	4.00
		5.80 ²	5.80
	M3.5 x 0.6	4.00	4.00
		7.20 ²	7.20
	M4 x 0.7	5.80	5.80
		8.20 ²	8.20
	M5 x 0.8	5.80	5.80
		8.20	8.20
		9.50 ²	9.50
	M6 x 1.0	7.20	7.20
		9.50	9.50
		12.70 ²	12.70
	M8 x 1.25	12.70 ²	12.70

- (1) All dimensions are in millimeters and reference unless toleranced.
- (2) Preferred length.
- (3) Custom insert lengths available by request.

BOSS DESIGN RECOMMENDATION

The EFZ Expansion Fin Zert is designed to be installed into a straight hole with a 1° inclusive taper. The top of the hole should not be countersunk or counterbored as this will decrease the insert's performance. The recommended hole size applies at the point reached by the bottom of the insert. Molded holes should be used wherever possible as drilled holes may result in diminished performance. Minimum boss wall thicknesses shown are for reference and may vary depending on the type of plastic.

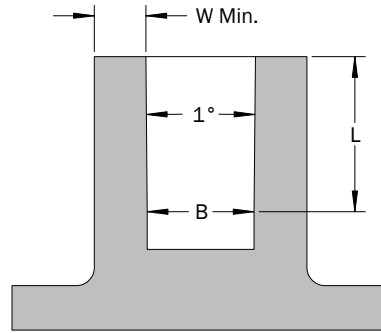

INSTALLATION

Press the insert into the boss using a squeezing action never a hammer blow. Ensure that the insert maintains axial alignment during installation to prevent tilting which will induce side loads on the boss. Oversize boss holes weaken the insert's self-aligning characteristics causing side loads which may lead to possible boss cracking. Install fixing screw from the knurled end with sufficient length to fully penetrate the insert and achieve maximum fin expansion prior to applying full clamping load.

PERFORMANCE

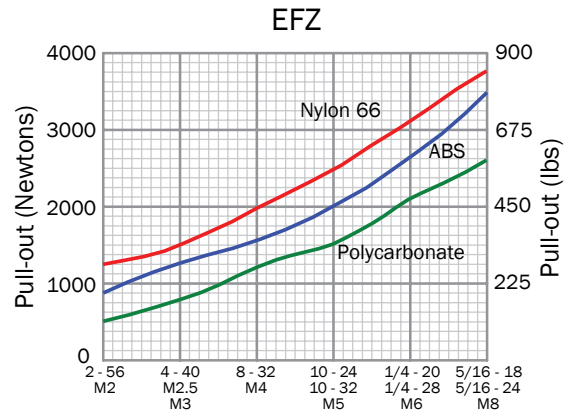

(1) Performance data shown is for preferred insert lengths and reference only. Variations in application, boss material type and size, and installation method will affect the loads. PENCOM strongly encourages testing in the application.



PFZ

Press-in Fin Zerts

FEATURES

- Simple press-in installation for most thermoplastics.
- High pull-out resistance.
- Self-aligning design.
- Available in a wide variety of thread sizes stud lengths.



PART DESCRIPTION EXAMPLE

PFZS	—	632	—	250 X 375	—	SS
Series Code		Insert or Stud Thread Code		Insert Length Code ¹ Stud Length Code ¹		Material Code ²

- (1) Omit stud length code for non-studded inserts.
 (2) SS material code designates stainless steel. Standard insert material is brass. Omit SS material code for brass inserts. Custom materials and finishes available by request.

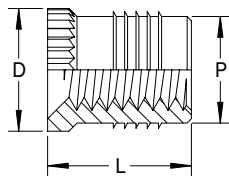

Insert
Series Code PFZ

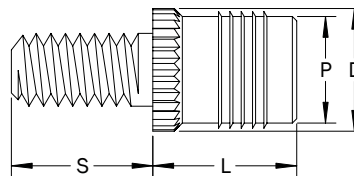

Insert w/ Stud
Series Code PFZS

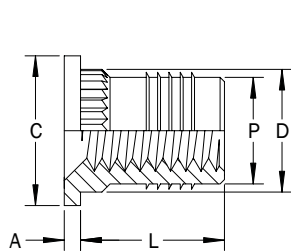

Headed Insert
Series Code PFZH

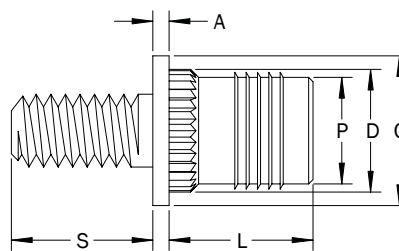

Headed Insert w/ Stud
Series Code PFZHS

GENERAL

	Insert Thread	Insert Thread Code	L Insert Length	Insert Length Code	Boss		A Head Thickness	C Head Diameter	D Insert Diameter	P Pilot Diameter	Number of Fins
					B Hole Dia. +.004 -.000	W Wall Thickness Min.					
INCH	2-56	256	.157	157	.126	.063	.018	.189	.147	.123	2
	4-40	440	.187	187	.157	.079	.023	.217	.178	.154	3
	6-32	632	.250	250	.189	.094	.029	.250	.209	.185	4
	8-32	832	.312	312	.220	.110	.035	.281	.240	.218	5
	10-24	1024	.375	375	.252	.126	.042	.312	.274	.248	5
	10-32	1032	.375	375	.252	.126	.042	.312	.274	.248	5
	1/4-20	2520	.500	500	.315	.157	.052	.375	.337	.310	7
	1/4-28	2528	.500	500	.315	.157	.052	.375	.337	.310	7
	5/16-18	3118	.500	500	.378	.189	.052	.433	.400	.375	7
	5/16-24	3124	.500	500	.378	.189	.052	.433	.400	.375	7

(1) All dimensions are in inches and reference unless tolerated.

	Insert Thread	Insert Thread Code	L Insert Length	Insert Length Code	Boss		A Head Thickness	C Head Diameter	D Insert Diameter	P Pilot Diameter	Number of Fins
					B Hole Dia. +0.10 - 0.00	W Wall Thickness Min.					
METRIC	M2 x 0.4	M2	4.00	4.00	3.20	1.60	0.45	4.80	3.73	3.10	2
	M2.5 x 0.45	M2.5	4.80	4.80	4.00	2.00	0.58	5.50	4.52	3.90	3
	M3 x 0.5	M3	4.80	4.80	4.00	2.00	0.58	5.50	4.52	3.90	3
	M3.5 x 0.6	M3.5	6.40	6.40	4.80	2.40	0.74	6.40	5.31	4.70	4
	M4 x 0.7	M4	7.90	7.90	5.60	2.80	0.89	7.10	6.10	5.50	5
	M5 x 0.8	M5	9.50	9.50	6.40	3.20	1.07	7.90	6.96	6.30	5
	M6 x 1.0	M6	12.70	12.70	8.00	4.00	1.32	9.50	8.56	7.90	7
	M8 x 1.25	M8	12.70	12.70	9.60	4.80	1.32	11.10	10.16	9.50	7

(1) All dimensions are in millimeters and reference unless tolerated.

STUD LENGTH

INCH	Stud Thread	Stud Thread Code	D Insert Diameter	S - Stud Length									
				.187	.250	.312	.375	.437	.500	.625	.750	.875	1.000
				Stud Length Code									
2-56	256	.147	187	250	312	—	—	—	—	—	—	—	
4-40	440	.178	187	250	312	375	437	—	—	—	—	—	
6-32	632	.209	187	250	312	375	437	500	—	—	—	—	
8-32	832	.240	187	250	312	375	437	500	625	—	—	—	
10-24	1024	.274	187	250	312	375	437	500	625	750	—	—	
10-32	1032	.274	187	250	312	375	437	500	625	750	—	—	
1/4-20	2520	.337	—	250	312	375	437	500	625	750	875	1000	
1/4-28	2528	.337	—	250	312	375	437	500	625	750	875	1000	
5/16-18	3118	.400	—	—	312	375	437	500	625	750	875	1000	
5/16-24	3124	.400	—	—	312	375	437	500	625	750	875	1000	

- (1) All dimensions are in inches and reference unless tolerated.
 (2) Custom stud lengths available by request.

METRIC	Stud Thread	Stud Thread Code	D Insert Diameter	S - Stud Length									
				5.00	6.00	8.00	10.00	12.00	14.00	16.00	18.00	20.00	25.00
				Stud Length Code									
M2 x 0.4	M2	3.73	5.00	6.00	8.00	—	—	—	—	—	—	—	
M2.5 x 0.45	M2.5	4.52	5.00	6.00	8.00	10.00	—	—	—	—	—	—	
M3 x 0.5	M3	4.52	5.00	6.00	8.00	10.00	12.00	—	—	—	—	—	
M3.5 x 0.6	M3.5	5.31	5.00	6.00	8.00	10.00	12.00	14.00	—	—	—	—	
M4 x 0.7	M4	6.10	5.00	6.00	8.00	10.00	12.00	14.00	16.00	—	—	—	
M5 x 0.8	M5	6.96	5.00	6.00	8.00	10.00	12.00	14.00	16.00	18.00	20.00	—	
M6 x 1.0	M6	8.56	—	6.00	8.00	10.00	12.00	14.00	16.00	18.00	20.00	25.00	
M8 x 1.25	M8	10.16	—	—	8.00	10.00	12.00	14.00	16.00	18.00	20.00	25.00	

- (1) All dimensions are in millimeters and reference unless tolerated.
 (2) Custom stud lengths available by request.

BOSS DESIGN RECOMMENDATION

The PFZ Press-in Fin Zert is designed to be installed into a straight hole with a 1° inclusive taper. The top of the hole should not be countersunk or counterbored as this will decrease the insert's performance. The recommended hole size applies at the point reached by the bottom of the insert. Molded holes should be used wherever possible as drilled holes may result in diminished performance. Minimum boss wall thicknesses shown are for reference and may vary depending on the type of plastic.

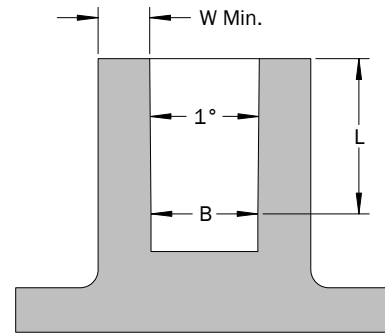

INSTALLATION

Press the insert into the boss using a squeezing action—never a hammer blow. Ensure that the insert maintains axial alignment during installation to prevent tilting which will induce side loads on the boss. Oversize boss holes weaken the insert's self-aligning characteristics causing side loads which may lead to possible boss cracking.

PERFORMANCE

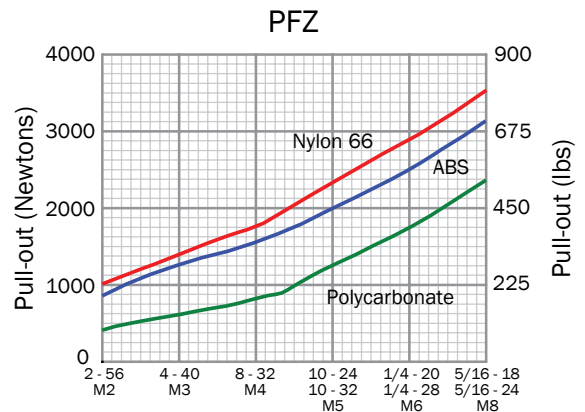

(1) Performance data shown is for reference only. Variations in application, boss material type and size, and installation method will affect the loads. PENCOM strongly encourages testing in the application.



PHZ

Press-in Hex Zerts

FEATURES

- Simple press-in installation for most thermoplastics.
- Hexagonal barbs provide high pull-out and torque-out resistance.
- Available in a wide variety of thread sizes.



PART DESCRIPTION EXAMPLE

PHZ — 632 — 230 — SS
T T T T
Series Code Insert Thread Code Insert Length Code Material Code¹

(1) SS material code designates stainless steel and is the standard insert material. Inserts also available in aluminum—replace SS material code with AL. Custom materials and finishes available by request.

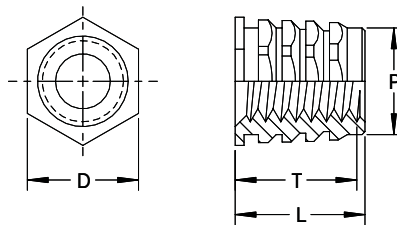

Insert
Series Code PHZ

PHZ Press-in Hex Zerts

GENERAL

	Insert Thread	Insert Thread Code	L Insert Length Max.	Insert Length Code	Boss		D Width Across Flats	P Pilot Diameter Max.	T Full Thread Depth Min. ²
					B Hole Dia. +.003 -0.000	W Wall Thickness Min.			
INCH	2-56	256	.230	230	.187	.157	.187	.186	.212
	4-40	440	.230	230	.187	.157	.187	.186	.212
	6-32	632	.230	230	.187	.157	.187	.186	.212
	8-32	832	.265	265	.250	.188	.250	.249	.248
	10-24	1024	.265	265	.250	.188	.250	.249	.248
	10-32	1032	.265	265	.250	.188	.250	.249	.248
	1/4-20	2520	.315	315	.312	.219	.312	.311	.300
	1/4-28	2528	.315	315	.312	.219	.312	.311	.300
	5/16-18	3118	.365	365	.375	.288	.375	.374	.345
	5/16-24	3124	.365	365	.375	.288	.375	.374	.345

- (1) All dimensions are in inches and reference unless tolerated.
 (2) Although thread is tapped thru, thread go-gauge may not pass beyond the T dimension.

	Insert Thread	Insert Thread Code	L Insert Length Max.	Insert Length Code	Boss		D Width Across Flats	P Pilot Diameter Max.	T Full Thread Depth Min. ²
					B Hole Dia. +0.08 -0.00	W Wall Thickness Min.			
METRIC	M2.5 x 0.45	M2.5	5.84	5.84	4.75	3.98	4.75	4.72	5.38
	M3 x 0.5	M3	5.84	5.84	4.75	3.98	4.75	4.72	5.38
	M3.5 x 0.6	M3.5	5.84	5.84	4.75	3.98	4.75	4.72	5.38
	M4 x 0.7	M4	6.73	6.73	6.35	4.77	6.35	6.32	6.30
	M5 x 0.8	M5	6.73	6.73	6.35	4.77	6.35	6.32	6.30
	M6 x 1.0	M6	8.00	8.00	7.92	5.57	7.92	7.89	7.62
	M8 x 1.25	M8	9.27	9.27	9.53	7.30	9.53	9.50	8.76

BOSS DESIGN RECOMMENDATION

The PHZ Press-in Hex Zert is designed to be installed into a straight hole with a 1° inclusive taper. The top of the hole should not be countersunk or counterbored as this will decrease the insert's performance. The recommended hole size applies at the point reached by the bottom of the insert. Molded holes should be used wherever possible as drilled holes may result in diminished performance. Minimum boss wall thicknesses shown are for reference and may vary depending on the type of plastic.

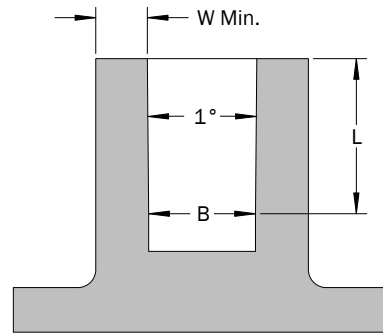

INSTALLATION

Press the insert into the boss using a squeezing action – never a hammer blow. Ensure that the insert maintains axial alignment during installation to prevent tilting which will induce side loads on the boss. Oversize boss holes weaken the insert's self-aligning characteristics causing side loads which may lead to possible boss cracking.

PERFORMANCE

INCH	Insert Thread Code	Boss Material	Installation (lbs)	Pull-out (lbs)	Torque-out (in-lbs)
	440	ABS	225	125	4
Polycarbonate		600	280	16	
632	ABS	225	125	4	
	Polycarbonate	600	280	16	
832	ABS	300	135	10	
	Polycarbonate	600	380	42	
1024 1032	ABS	300	135	10	
	Polycarbonate	600	380	42	
2520 2528	ABS	400	235	28	
	Polycarbonate	—	—	—	

(1) Performance data shown is for reference only. Variations in application, boss material type and size, and installation method will affect the loads. PENCOM strongly encourages testing in the application.

METRIC	Insert Thread Code	Boss Material	Installation (kN)	Pull-out (N)	Torque-out (N-m)
	M3	ABS	1.00	556	0.45
Polycarbonate		2.67	1245	1.80	
M4	ABS	1.33	600	1.13	
	Polycarbonate	2.67	1690	4.74	
M5	ABS	1.33	600	1.13	
	Polycarbonate	2.67	1690	4.74	
M6	ABS	1.78	1045	3.16	
	Polycarbonate	—	—	—	

(1) Performance data shown is for reference only. Variations in application, boss material type and size, and installation method will affect the loads. PENCOM strongly encourages testing in the application.



TSZ

Thermoset Zerts

FEATURES

- Simple press-in installation.
- Sharp helical knurls broach into thermoset materials to provide high torque-out resistance.
- Self-aligning design.
- Available in a wide variety of thread sizes, stud lengths and options.



PART DESCRIPTION EXAMPLE

TSZS	—	632	—	247	X	375	—	SS
T		T		T		T		T
Series Code		Insert or Stud Thread Code		Insert Length Code		Stud Length Code ¹		Material Code ²

- (1) Omit stud length code for non-studded inserts.
- (2) SS material code designates stainless steel. Standard insert material is brass. Omit SS material code for brass inserts. Custom materials and finishes available by request.

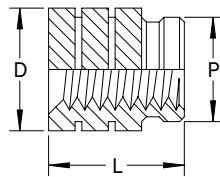

Insert
Series Code TSZ

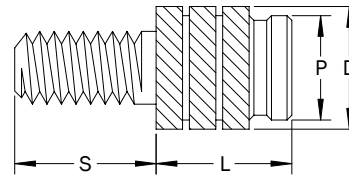

Insert w/ Stud
Series Code TSZS

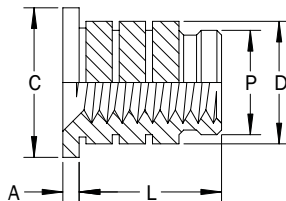

Headed Insert
Series Code TSZH

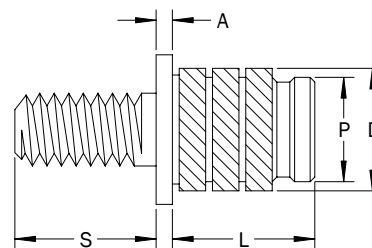

Headed Insert w/ Stud
Series Code TSZHS

TSZ Thermoset Zerts

GENERAL

	Insert Thread	Insert Thread Code	L Insert Length	Insert Length Code	Boss		A Head Thickness	C Head Diameter	D Insert Diameter	P Pilot Diameter
					B Hole Dia. +.004 -.000	W Wall Thickness Min.				
INCH	2-56	256	.162	162	.122	.063	.020	.187	.131	.117
	4-40	440	.208	208	.150	.079	.023	.217	.165	.146
	6-32	632	.247	247	.181	.098	.029	.250	.196	.178
	8-32	832	.292	292	.213	.098	.035	.281	.228	.209
	10-24	1024	.326	326	.244	.098	.042	.312	.259	.241
	10-32	1032	.326	326	.244	.098	.042	.312	.259	.241
	1/4-20	2520	.362	362	.307	.110	.052	.375	.332	.304
	1/4-28	2528	.362	362	.307	.110	.052	.375	.332	.304
	5/16-18	3118	.362	362	.366	.150	.052	.437	.383	.365
	5/16-24	3124	.362	362	.366	.150	.052	.437	.383	.365
	3/8-16	3716	.362	362	.484	.197	.062	.551	.499	.481
3/8-24	3724	.362	362	.484	.197	.062	.551	.499	.481	

(1) All dimensions are in inches and reference unless tolerated.

	Insert Thread	Insert Thread Code	L Insert Length	Insert Length Code	Boss		A Head Thickness	C Head Diameter	D Insert Diameter	P Pilot Diameter
					B Hole Dia. +0.10 - 0.00	W Wall Thickness Min.				
METRIC	M2 x 0.4	M2	4.10	4.10	3.10	1.60	0.51	4.80	3.30	3.00
	M2.5 x 0.45	M2.5	5.30	5.30	3.80	2.00	0.58	5.50	4.20	3.70
	M3 x 0.5	M3	5.30	5.30	3.80	2.00	0.58	5.50	4.20	3.70
	M3.5 x 0.6	M3.5	6.30	6.30	4.60	2.50	0.74	6.40	5.00	4.50
	M4 x 0.7	M4	7.40	7.40	5.40	2.50	0.89	7.10	5.80	5.30
	M5 x 0.8	M5	8.30	8.30	6.20	2.50	1.07	7.90	6.60	6.10
	M6 x 1.0	M6	9.20	9.20	7.80	2.80	1.32	9.50	8.20	7.70
	M8 x 1.25	M8	9.20	9.20	9.30	3.80	1.32	11.10	9.70	9.30
	M10 x 1.5	M10	9.20	9.20	12.30	5.00	1.57	14.00	12.70	12.20

(1) All dimensions are in millimeters and reference unless tolerated.

STUD LENGTH

INCH	Stud Thread	Stud Thread Code	D Insert Diameter	S - Stud Length									
				.187	.250	.312	.375	.437	.500	.625	.750	.875	1.000
				Stud Length Code									
	2-56	256	.131	187	250	312	—	—	—	—	—	—	—
	4-40	440	.165	187	250	312	375	437	—	—	—	—	—
	6-32	632	.196	187	250	312	375	437	500	—	—	—	—
	8-32	832	.228	187	250	312	375	437	500	625	—	—	—
	10-24	1024	.259	187	250	312	375	437	500	625	750	—	—
	10-32	1032	.259	187	250	312	375	437	500	625	750	—	—
	1/4-20	2520	.332	—	250	312	375	437	500	625	750	875	1000
	1/4-28	2528	.332	—	250	312	375	437	500	625	750	875	1000
	5/16-18	3118	.383	—	—	312	375	437	500	625	750	875	1000
	5/16-24	3124	.383	—	—	312	375	437	500	625	750	875	1000
	3/8-16	3716	.499	—	—	—	375	437	500	625	750	875	1000
	3/8-24	3724	.499	—	—	—	375	437	500	625	750	875	1000

- (1) All dimensions are in inches and reference unless toleranced.
 (2) Custom stud lengths available by request.

METRIC	Stud Thread	Stud Thread Code	D Insert Diameter	S - Stud Length									
				5.00	6.00	8.00	10.00	12.00	14.00	16.00	18.00	20.00	25.00
				Stud Length Code									
	M2 x 0.4	M2	3.30	5.00	6.00	8.00	—	—	—	—	—	—	—
	M2.5 x 0.45	M2.5	4.20	5.00	6.00	8.00	10.00	—	—	—	—	—	—
	M3 x 0.5	M3	4.20	5.00	6.00	8.00	10.00	12.00	—	—	—	—	—
	M3.5 x 0.6	M3.5	5.00	5.00	6.00	8.00	10.00	12.00	14.00	—	—	—	—
	M4 x 0.7	M4	5.80	5.00	6.00	8.00	10.00	12.00	14.00	16.00	—	—	—
	M5 x 0.8	M5	6.60	5.00	6.00	8.00	10.00	12.00	14.00	16.00	18.00	20.00	—
	M6 x 1.0	M6	8.20	—	6.00	8.00	10.00	12.00	14.00	16.00	18.00	20.00	25.00
	M8 x 1.25	M8	9.70	—	—	8.00	10.00	12.00	14.00	16.00	18.00	20.00	25.00
	M10 x 1.5	M10	12.70	—	—	—	10.00	12.00	14.00	16.00	18.00	20.00	25.00

- (1) All dimensions are in millimeters and reference unless toleranced.
 (2) Custom stud lengths available by request.

BOSS DESIGN RECOMMENDATION

The TSZ Thermoset Zert is designed to be installed into a straight hole with a 1° inclusive taper. The top of the hole should not be countersunk or counterbored as this will decrease the insert's performance. The recommended hole size applies at the point reached by the bottom of the insert. Molded holes should be used wherever possible as drilled holes may result in diminished performance. Minimum boss wall thicknesses shown are for reference and may vary depending on the type of plastic.

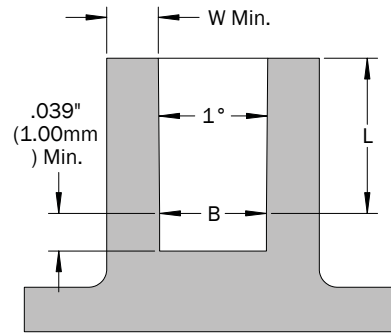

INSTALLATION

Press the insert into the boss using a squeezing action – never a hammer blow. Allow the insert to rotate in the direction of the knurl during installation by using a punch with either a polished face or thrust bearing. Ensure that the insert maintains axial alignment during installation to prevent tilting which will induce side loads on the boss. Oversize boss holes weaken the insert's self-aligning characteristics causing side loads which may lead to possible boss cracking.

PERFORMANCE

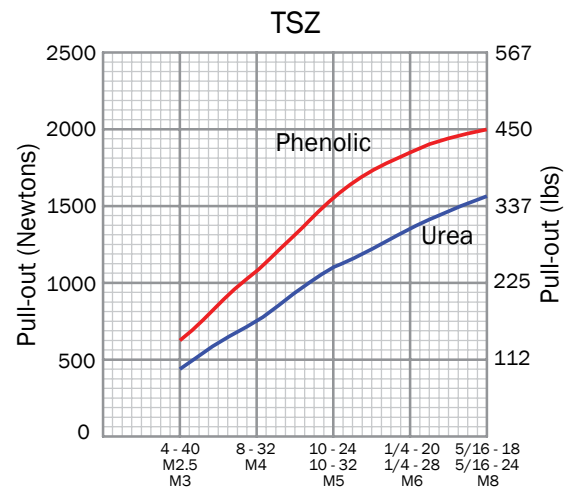

(1) Performance data shown is for reference only. Variations in application, boss material type and size, and installation method will affect the loads. PENCOM strongly encourages testing in the application.



SSZ

Screw Zerts

FEATURES

- Self-tapping installation in a variety of materials.
- High pull-out resistance in weak plastics.
- Suitable for applications where jack-out is unavoidable.



PART DESCRIPTION EXAMPLE

SSZS — 632 — 315 X 375 — SS

T
T
T
T
T

Series Code Insert or Stud Thread Code Insert Length Code Stud Length Code¹ Material Code²

- (1) Omit stud length code for non-studded inserts.
- (2) SS material code designates stainless steel. Standard insert material is brass. Omit SS material code for brass inserts. Custom materials and finishes available by request.

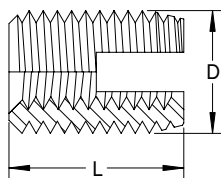

Insert
Series Code SSZ

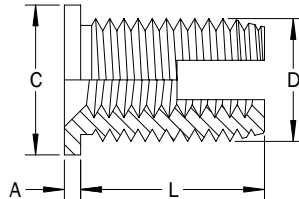

Headed Insert
Series Code SSZH

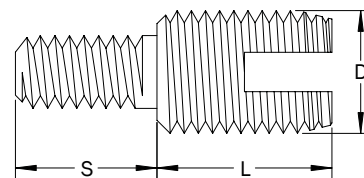

Insert w/ Stud
Series Code SSZS

SSZ Screw Zerts

GENERAL

	Insert Thread	Insert Thread Code	L Insert Length	Insert Length Code	Boss Hole Dia. B		A Head Thickness	C Head Diameter	D Insert Diameter Max.
					Thermo-plastics +.004 -.000	Thermo-setting +.004 -.000			
INCH	2-56	256	.236	236	.157-.161	.161-.169	.023	.236	.177
	4-40	440	.236	236	.157-.161	.161-.169	.023	.236	.177
	6-32	632	.315	315	.209-.213	.217-.224	.029	.295	.236
	8-32	832	.315	315	.228-.232	.236-.244	.035	.312	.256
	10-24	1024	.394	394	.280-.283	.287-.299	.042	.374	.315
	10-32	1032	.394	394	.280-.283	.287-.299	.042	.374	.315
	1/4-20	2520	.551	551	.339-.346	.354-.370	.052	.472	.394
	1/4-28	2528	.551	551	.339-.346	.354-.370	.052	.472	.394
	5/16-18	3118	.591	591	.417-.425	.433-.449	.052	.551	.472
	5/16-24	3124	.591	591	.417-.425	.433-.449	.052	.551	.472
	3/8-16	3716	.709	709	.496-.504	.512-.528	.062	.630	.551
	3/8-24	3724	.709	709	.496-.504	.512-.528	.062	.630	.551
	1/2-13	5013	.866	866	.575-.583	.591-.606	.062	.709	.630
	1/2-20	5020	.866	866	.575-.583	.591-.606	.062	.709	.630

- (1) All dimensions are in inches and reference unless toleranced.
- (2) Pencom recommends determining the minimum hole wall thickness through testing in the application.

	Insert Thread	Insert Thread Code	L Insert Length	Insert Length Code	Boss Hole Dia. B		A Head Thickness	C Head Diameter	D Insert Diameter Max.
					Thermo-plastics +0.10 - 0.00	Thermo-setting +0.10 - 0.00			
METRIC	M2 x 0.4	M2	6.00	6.00	4.00-4.10	4.10-4.30	0.58	6.00	4.50
	M2.5 x 0.45	M2.5	6.00	6.00	4.00-4.10	4.10-4.30	0.58	6.00	4.50
	M3 x 0.5	M3	6.00	6.00	4.50-4.60	4.60-4.80	0.58	6.50	5.00
	M3.5 x 0.6	M3.5	8.00	8.00	5.30-5.40	5.50-5.70	0.73	7.50	6.00
	M4 x 0.7	M4	8.00	8.00	5.80-5.90	6.00-6.20	0.89	8.00	6.50
	M5 x 0.8	M5	10.00	10.00	7.10-7.20	7.30-7.60	1.06	9.50	8.00
	M6 x 1.0	M6	14.00	14.00	8.60-8.80	9.00-9.40	1.32	12.00	10.00
	M8 x 1.25	M8	15.00	15.00	10.60-10.80	11.00-11.40	1.32	14.00	12.00
	M10 x 1.5	M10	18.00	18.00	12.60-12.80	13.00-13.40	1.57	16.00	14.00
	M12 x 1.75	M12	22.00	22.00	14.60-14.80	15.00-15.40	1.57	18.00	16.0

- (1) All dimensions are in millimeters and reference unless toleranced.
- (2) Pencom recommends determining the minimum hole wall thickness through testing in the application.

STUD LENGTH

	Stud Thread	Stud Thread Code	D Insert Diameter Max.	S-Stud Length									
				.187	.250	.312	.375	.437	.500	.625	.750	.875	1.000
				Stud Length Code									
INCH	2-56	256	.177	187	250	312	—	—	—	—	—	—	—
	4-40	440	.177	187	250	312	375	437	—	—	—	—	—
	6-32	632	.236	187	250	312	375	437	500	—	—	—	—
	8-32	832	.256	187	250	312	375	437	500	625	—	—	—
	10-24	1024	.315	187	250	312	375	437	500	625	750	—	—
	10-32	1032	.315	187	250	312	375	437	500	625	750	—	--
	1/4-20	2520	.394	—	250	312	375	437	500	625	750	875	1000
	1/4-28	2528	.394	—	250	312	375	437	500	625	750	875	1000
	5/16-18	3118	.472	—	—	312	375	437	500	625	750	875	1000
	5/16-24	3124	.472	—	—	312	375	437	500	625	750	875	1000
	3/8-16	3716	.551	—	—	—	375	437	500	625	750	875	1000
	3/8-24	3724	.551	—	—	—	375	437	500	625	750	875	1000
	1/2-13	5013	.630	—	—	—	—	—	500	625	750	875	1000
1/2-20	5020	.630	—	—	—	—	—	500	625	750	875	1000	

- (1) All dimensions are in inches and reference unless tolerated.
 (2) Custom stud lengths available by request.

	Stud Thread	Stud Thread Code	D Insert Diameter Max.	S-Stud Length									
				5.00	6.00	8.00	10.00	12.00	14.00	16.00	18.00	20.00	25.00
				Stud Length Code									
METRIC	M2 x 0.4	M2	4.50	5.00	6.00	8.00	—	—	—	—	—	—	—
	M2.5 x 0.45	M2.5	4.50	5.00	6.00	8.00	10.00	—	—	—	—	—	—
	M3 x 0.5	M3	5.00	5.00	6.00	8.00	10.00	12.00	—	—	—	—	—
	M3.5 x 0.6	M3.5	6.00	5.00	6.00	8.00	10.00	12.00	14.00	—	—	—	—
	M4 x 0.7	M4	6.50	5.00	6.00	8.00	10.00	12.00	14.00	16.00	—	—	—
	M5 x 0.8	M5	8.00	5.00	6.00	8.00	10.00	12.00	14.00	16.00	18.00	20.00	—
	M6 x 1.0	M6	10.00	—	6.00	8.00	10.00	12.00	14.00	16.00	18.00	20.00	25.00
	M8 x 1.25	M8	12.00	—	—	8.00	10.00	12.00	14.00	16.00	18.00	20.00	25.00
	M10 x 1.5	M10	14.00	—	—	—	10.00	12.00	14.00	16.00	18.00	20.00	25.00
	M12 x 1.75	M12	16.00	—	—	—	—	12.00	14.00	16.00	18.00	20.00	25.00

- (1) All dimensions are in millimeters and reference unless tolerated.
 (2) Custom stud lengths available by request.

BOSS DESIGN RECOMMENDATION

The SSZ Screw Zert is designed to be installed into a straight hole with a 1° inclusive taper. The recommended hole size applies at the point reached by the bottom of the insert. Molded holes should be used wherever possible as drilled holes may result in diminished performance. PENCOR recommends a 60° countersink, with a depth equal to the external thread pitch of the insert being used, at the top of the hole to prevent chipping of the surrounding boss hole surface. Hole diameters are dependent on the type of plastic being used with harder plastics requiring larger holes than softer plastics, for example. Diameter ranges shown in the tables are those recommended for thermoplastics and thermosetting plastics with the exact hole size determined through testing in the application.

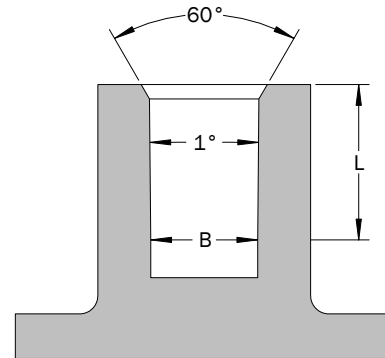

INSTALLATION

The slot in the insert acts as a thread cutting edge. Inserts are installed following standard tapping procedures using hand tools or conventional tapping equipment.



FTZ

Fix Tite Zerts

FEATURES

- Counterbore facilitates placement on mold locating pin, prevents entry of plastic, and aids start of mating fastener.
- Blind end prevents ingress of plastic and contaminating threads.
- No cut-off pip on blind end ensures smooth operation in automatic feeding equipment.



PART DESCRIPTION EXAMPLE

FTZ	—	M3.5	—	9.20	—	SS
T		T		T		T
Series Code		Insert Thread Code		Insert Length Code		Material Code ¹

(1) SS material code designates stainless steel. Standard insert material is brass. Omit SS material code for brass inserts or use material code AL for aluminum inserts. Custom materials and finishes available by request.

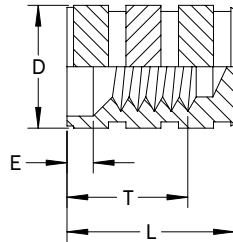

Insert
Series Code FTZ

FTZ Fix Tite Zerts

GENERAL

	Insert Thread	Insert Thread Code	L Insert Length	Insert Length Code	D Insert Diameter	E C'bore Depth	T Thread Depth Min.	Locating Pin					
								G +0.040 -0.020	H +0.000 -0.025	J +0.100 -0.100	K +0.0125 -0.0125	M Degrees Inclusive	N
METRIC	M2 x 0.4	M2	5.50	5.50	3.40	1.00	3.60	0.80	1.55	2.65	2.300	6.0	3.00
	M2.5 x 0.45	M2.5	6.40	6.40	4.30	1.20	4.00	0.90	2.00	3.00	2.800	5.0	3.50
	M3 x 0.5	M3	7.30	7.30	4.70	1.30	4.60	1.05	2.45	3.40	3.125	4.5	4.00
	M3.5 x 0.6	M3.5	9.20	9.20	5.50	1.60	6.00	1.30	2.85	4.55	3.750	4.5	4.70
	M4 x 0.7	M4	10.20	10.20	6.30	1.80	6.70	1.55	3.25	5.00	4.425	4.5	5.40
	M5 x 0.8	M5	11.20	11.20	7.30	2.00	7.40	1.70	4.15	5.55	5.125	5.0	6.00
	M6 x 1.0	M6	14.40	14.40	9.80	2.00	8.10	1.80	4.95	6.15	6.600	5.5	8.00
	M8 x 1.25	M8	16.50	16.50	11.40	2.30	11.10	2.00	6.70	9.00	8.500	6.0	10.00
M10 x 1.5	M10	17.90	17.90	13.80	2.40	11.90	2.10	8.40	9.70	10.500	6.0	12.00	

(1) All dimensions are in millimeters and reference unless toleranced.

INSTALLATION

The FTZ Fix Tite Zert is designed to be molded into the host plastic using a core pin to locate the insert in the mold. A good fit between the locating pin and insert will aid insert location and retention, and prevent plastic from flowing into the threads.

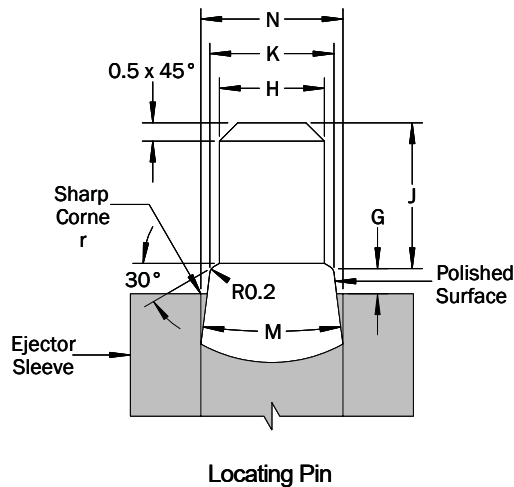



HXZ

Molded Hex Zerts

FEATURES

- Hex shape provides high torque-out resistance when molded in soft thermoplastic materials.
- An excellent choice for rotational molding applications.
- Available with blind or thru-hole threads.
- Inserts with thru-hole threads are symmetrical and may be used from either end.
- Standard insert material is brass. Other materials available by request.



PART DESCRIPTION EXAMPLE

HXZ — 832 — 394 — BLIND
 T — T — T — T
 Series Code Thread Code Length Code Type Code¹

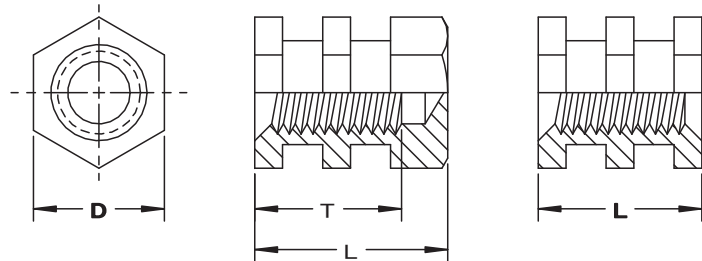

(1) BLIND type code designates insert with blind threads. Substitute BLIND with THRU for insert with thru-hole threads.

Type Code
BLIND

Type Code
THRU

GENERAL - BLIND

	Insert Thread	Insert Thread Code	L Insert Length	Insert Length Code	D Width Across Flats	T Min. Thread Depth	Number of Vanes ¹
INCH	4-40	440	.315	315	.236	.200	3
	6-32	632	.375	375	.250	.219	3
	8-32	832	.394	394	.315	.250	3
	10-24	1024	.394	394	.315	.208	3
			.591	591		.417	4
			.748	748		.583	5
	10-32	1032	.394	394	.315	.250	3
			.591	591		.438	4
			.748	748		.563	5
	1/4-20	2520	.591	591	.394	.375	4
	5/16-18	3118	.630	630	.472	.390	4
	3/8-16	3716	.748	748	.551	.438	5
.984			984	.688		5	

(1) Vanes may not be of equal width or spacing.

(2) Custom sizes available by request.

HXZ Molded Hex Zerts

GENERAL - BLIND (CONTINUED)

METRIC	Insert Thread	Insert Thread Code	L Insert Length	Insert Length Code	D Width Across Flats	T Min. Thread Depth	Number of Vanes ¹
	M3 x 0.5	M3	8.00	8.00	6.00	5.00	3
	M4 x 0.7	M4	10.00	10.00	8.00	6.30	3
	M5 x 0.8	M5	10.00	10.00	8.00	6.40	3
			15.00	15.00		11.00	4
			19.00	19.00		12.80	5
	M6 x 1.0	M6	15.00	15.00	10.00	11.00	4
	M8 x 1.25	M8	16.00	16.00	12.00	11.00	4
	M10 x 1.5	M10	19.00	19.00	14.00	15.00	5
25.00			25.00	18.00		5	

- (1) Vanes may not be of equal width or spacing.
- (2) Custom sizes available by request.

GENERAL - THRU

INCH	Insert Thread	Insert Thread Code	L Insert Length	Insert Length Code	D Width Across Flats	Number of Vanes
	4-40	440	.236	236	.236	2
	6-32	632	.250	250	.250	2
	8-32	832	.315	315	.315	3
	10-24	1024	.315	315	.315	3
			.394	394		3
	10-32	1032	.315	315	.315	3
			.394	394		3
	1/4-20	2520	.394	394	.394	3
			.472	472		3
	5/16-18	3118	.472	472	.472	3
			.630	630		4
	3/8-16	3716	.551	551	.551	3
			.748	748		4

- (1) Custom sizes available by request.

GENERAL - THRU (CONTINUED)

METRIC	Insert Thread	Insert Thread Code	L Insert Length	Insert Length Code	D Width Across Flats	Number of Vanes
	M3 x 0.5	M3	6.00	6.00	6.00	2
	M4 x 0.7	M4	8.00	8.00	8.00	3
	M5 x 0.8	M5	8.00	8.00	8.00	3
			10.00	10.00		3
	M6 x 1.0	M6	10.00	10.00	10.00	3
			12.00	12.00		3
	M8 x 1.25	M8	12.00	12.00	12.00	3
			16.00	16.00		4
	M10 x 1.5	M10	14.00	14.00	14.00	3
19.00			19.00	4		

(1) Custom sizes available by request.

INSTALLATION

The HXZ Molded Hex Zert should be placed on a core pin prior to molding into the host plastic. For rotational molding applications, a threaded or pin with detent features is typically used.

For more information go to www.pencomsf.com

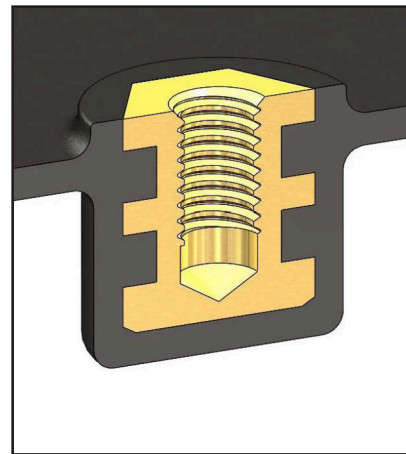



MBZ

Molded Blind Zerts

FEATURES

- Design provides excellent performance when molded in thermoplastics and thermosetting plastics.
- Blind end prevents ingress of plastic and contaminating threads.
- Large selection of insert threads and lengths.



PART DESCRIPTION EXAMPLE

MBZ	—	632	—	406	—	SS
Series Code		Insert Thread Code		Insert Length Code		Material Code ¹

(1) SS material code designates stainless steel. Standard insert material is brass. Omit SS material code for brass inserts. Custom materials and finishes available by request.

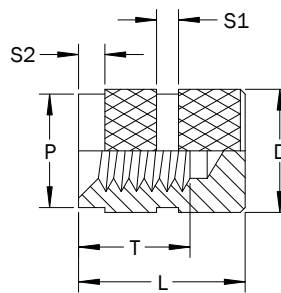

Insert
Series Code MBZ

MBZ Molded Blind Zerts

GENERAL

INCH	Insert Thread	Insert Thread Code	D Stock Dia. Before Knurl	P End Diameter ±.005	S1	S2	Thread Minor Diameter
	2-56	256	.156	.142	.030	.030	.0670-.0737
	4-40	440	.188	.171	.030	.030	.0860-.0939
	6-32	632	.219	.202	.030	.060	.105-.114
	8-32	832	.250	.226	.050	.060	.131-.139
	10-24	1024	.281	.259	.050	.060	.146-.156
	10-32	1032	.281	.259	.050	.060	.157-.164
	1/4-20	2520	.344	.321	.060	.090	.197-.207
	1/4-28	2528	.344	.321	.060	.090	.212-.220
	5/16-18	3118	.438	.404	.078	.094	.260-.265
3/8-16	3716	.500	.466	.094	.094	.309-.321	

(1) All dimensions are in inches and reference unless toleranced.

METRIC	Insert Thread	Insert Thread Code	D Stock Dia. Before Knurl	P End Diameter ±0.13	S1	S2	Thread Minor Diameter
	M2 x 0.4	M2	3.96	3.61	0.80	0.80	1.58-1.67
	M2.5 x 0.45	M2.5	4.78	4.34	0.80	0.80	2.03-2.14
	M3 x 0.5	M3	4.78	4.34	0.80	0.80	2.47-2.59
	M3.5 x 0.6	M3.5	5.56	5.13	0.80	1.60	2.87-3.01
	M4 x 0.7	M4	6.35	5.74	1.20	1.60	3.25-3.42
	M5 x 0.8	M5	7.14	6.57	1.20	1.60	4.15-4.34
	M6 x 1.0	M6	8.74	8.15	1.60	2.40	4.94-5.16
M8 x 1.25	M8	11.13	10.26	1.98	2.40	6.78-6.92	

(1) All dimensions are in millimeters and reference unless toleranced.

INSERT LENGTH

INCH	Insert Thread	L Insert Length ±.005	Insert Length Code	T Thread Depth Min.
	2-56		.156	156
		.219	219	.140
		.250	250	.170
		.290	290	.178
		.312	312	.215
		.330	330	.233
		.344	344	.250
4-40		.188	188	.100
		.205	205	.110
		.281	281	.170
		.344	344	.230
		.406	406	.280
		.438	438	.325
		.468	468	.355
6-32		.219	219	.125
		.250	250	.135
		.344	344	.210
		.406	406	.270
		.469	469	.335
		.484	484	.350
		.531	531	.395
8-32		.250	250	.135
		.344	344	.220
		.406	406	.285
		.469	469	.345
		.484	484	.360
10-24		.531	531	.395
		.312	312	.166
		.356	356	.175
		.438	438	.260
		.469	469	.291
		.531	531	.345
		.625	625	.425
		.656	656	.500
	.716	716	.510	

(1) All dimensions are in inches and reference unless tolerated.

METRIC	Insert Thread	L Insert Length ±0.13	Insert Length Code	T Thread Depth Min.
	M2 x 0.4		3.96	3.96
		5.56	5.56	2.40
		6.35	6.35	3.20
		7.37	7.37	4.00
		8.38	8.38	4.80
M2.5 x 0.45		4.78	4.78	2.77
		6.35	6.35	3.68
		7.14	7.14	4.57
		9.53	9.53	5.46
M3 x 0.5		10.31	10.31	6.35
		4.78	4.78	2.00
		5.21	5.21	3.00
		7.13	7.13	4.30
M3.5 x 0.6		8.73	8.73	5.80
		10.31	10.31	7.10
		11.13	11.13	8.30
		11.89	11.89	9.06
		5.56	5.56	2.40
M4 x 0.7		6.35	6.35	3.30
		8.73	8.73	5.60
		10.31	10.31	7.20
		11.91	11.91	8.80
		12.29	12.29	9.18
M5 x 0.8		13.48	13.48	10.00
		7.13	7.13	3.90
		11.12	11.12	6.10
		11.91	11.91	8.80
		13.48	13.48	10.30

(1) All dimensions are in millimeters and reference unless tolerated.

MBZ Molded Blind Zerts

INSERT LENGTH (CONTINUED)

INCH	Insert Thread	L Insert Length ±.005	Insert Length Code	T Thread Depth Min.
	10-32		.281	281
		.438	438	.240
		.469	469	.345
		.531	531	.405
1/4-20 1/4-28		.344	344	.200
		.375	375	.231
		.531	531	.355
		.625	625	.450
		.688	688	.500
		.719	719	.540
		.750	750	.600
		.819	819	.640
5/16-18		.438	438	.240
		.469	469	.271
		.594	594	.345
		.719	719	.490
		.811	811	.570
3/8-16		.949	949	.720
		.500	500	.275
		.562	562	.330
		.688	688	.430
		.812	812	.550
	.935	935	.660	
	1.000	1.000	.765	

(1) All dimensions are in inches and reference unless tolerated.

METRIC	Insert Thread	L Insert Length ±0.13	Insert Length Code	T Thread Depth Min.
	M6 x 1.0		8.73	8.73
		9.53	9.53	5.63
		13.49	13.49	7.62
		15.87	15.87	9.53
		17.48	17.48	10.00
		18.26	18.26	11.57
		19.05	19.05	12.00
		20.80	20.80	13.59
M8 x 1.25		11.13	11.13	5.72
		11.91	11.91	6.49
		15.09	15.09	8.64
		18.24	18.24	11.55
		20.62	20.62	14.09
		22.23		

(1) All dimensions are in millimeters and reference unless tolerated.

INSTALLATION

The MBZ Molded Blind Zert is designed to be molded into the host plastic using a core pin to locate the insert in the mold. A good fit between the core pin and insert will prevent plastic from flowing into the threads.

PERFORMANCE

INCH	Insert Thread Code	Insert Length Code	Host Material	Pull-out (lbs)	Torque-out (in-lbs)
	256	.219	ABS	140-148	5.5-5.8
			Polycarbonate	158-165	5.8-6.2
		.312	ABS	143-150	5.7-6.0
			Polycarbonate	160-167	5.9-6.4
	440	.281	ABS	240-250	5.7-6.2
			Polycarbonate	253-265	6.5-6.9
		.406	ABS	243-252	5.9-6.4
			Polycarbonate	262-268	6.6-7.0
	632	.344	ABS	415-425	8.0-8.5
Polycarbonate			440-455	8.7-9.2	
.469		ABS	420-428	8.2-8.6	
		Polycarbonate	452-458	8.8-9.3	
832	.344	ABS	521-530	14.1-15.0	
		Polycarbonate	536-545	15.4-16.1	
	.469	ABS	526-533	15.0-15.8	
		Polycarbonate	540-547	15.8-16.4	
1024 1032	.438	ABS	624-635	52-57	
		Polycarbonate	640-648	56-59	
	.469	ABS	629-637	54-58	
		Polycarbonate	646-651	57-60	
2520 2528	.531	ABS	895-910	103-108	
		Polycarbonate	912-928	107-111	

(1) All dimensions are in inches and reference unless tolerated.

PERFORMANCE (CONTINUED)

METRIC	Insert Thread Code	Insert Length Code	Host Material	Pull-out (kN)	Torque-out (N-m)
	M2	5.56	ABS	0.62-0.66	0.62-0.66
			Polycarbonate	0.70-0.73	0.66-0.70
		8.38	ABS	0.64-0.67	0.64-0.68
			Polycarbonate	0.71-0.74	0.67-0.72
	M2.5	6.35	ABS 0.70	1.06-1.11	0.64-
			Polycarbonate	1.12-1.17	0.73-0.77
		9.53	ABS	1.08-1.12	0.66-0.72
			Polycarbonate	1.16-1.19	0.74-0.79
	M3	7.13	ABS	1.06-1.11	0.64-0.70
Polycarbonate			1.12-1.17	0.73-0.77	
10.31		ABS	1.08-1.12	0.66-0.72	
		Polycarbonate	1.16-1.19	0.74-0.79	
M4	8.73	ABS	2.31-2.35	1.59-1.69	
		Polycarbonate	2.38-2.42	1.74-1.81	
	11.91	ABS	2.33-2.37	1.69-1.78	
		Polycarbonate	2.40-2.43	1.79-1.85	
M5	11.12	ABS	2.77-2.82	5.87-6.44	
		Polycarbonate	2.84-2.88	6.32-6.66	
	11.91	ABS	2.79-2.83	6.10-6.55	
		Polycarbonate	2.87-2.89	6.44-6.78	
M6	13.49	ABS	3.98-4.04	11.6-12.2	
		Polycarbonate	4.05-4.12	12.0-12.5	

(1) All dimensions are in millimeters and reference unless tolerated.



MTZ

Molded Thru-hole Zerts

FEATURES

- Design provides excellent performance when molded in thermoplastics and thermosetting plastics.
- Tapped open end allows screw to pass through the insert.
- Custom lengths available by request.



PART DESCRIPTION EXAMPLE

MTZ	—	632	—	219	—	SS
T		T		T		T
Series Code		Insert Thread Code		Insert Length Code		Material Code ¹

(1) SS material code designates stainless steel. Standard insert material is brass. Omit SS material code for brass inserts or use material code AL for aluminum inserts. Custom materials and finishes available by request.

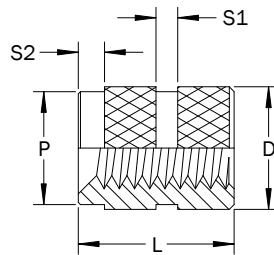

Insert
Series Code MTZ

MTZ Molded Thru-hole Zerts

GENERAL

INCH	Insert Thread	Insert Thread Code	L Insert Length ±.005	Insert Length Code	D Stock Dia. Before Knurl	P End Diameter ±.005	S1	S2	Thread Minor Diameter
	0-80	080	.125	125	.109	.078	.030	.030	.0475-.0510
	2-56	256	.125	125	.156	.142	.030	.030	.0670-.0737
	4-40	440	.188	188	.188	.171	.030	.030	.0860-.0939
	6-32	632	.219	219	.219	.202	.030	.060	.105-.114
	8-32	832	.250	250	.250	.226	.050	.060	.131-.139
	10-24	1024	.281	281	.281	.259	.050	.060	.146-.156
	10-32	1032	.281	281	.281	.259	.050	.060	.157-.164
	1/4-20	2520	.375	375	.344	.321	.060	.090	.197-.207
	1/4-28	2528	.375	375	.344	.321	.060	.090	.212-.220
	5/16-18	3118	.469	469	.437	.404	.080	.090	.260-.265
3/8-16	3716	.562	562	.500	.466	.090	.090	.309-.321	

(1) All dimensions are in inches and reference unless toleranced.

METRIC	Insert Thread	Insert Thread Code	L Insert Length ±0.13	Insert Length Code	D Stock Dia. Before Knurl	P End Diameter ±0.13	S1	S2	Thread Minor Diameter
	M2 x 0.4	M2	3.18	3.18	3.96	3.61	0.78	0.78	1.58-1.67
	M2.5 x 0.45	M2.5	4.77	4.77	4.77	4.34	0.78	0.78	2.03-2.14
	M3 x 0.5	M3	4.77	4.77	4.77	4.34	0.78	0.78	2.47-2.59
	M3.5 x 0.6	M3.5	5.56	5.56	5.56	5.13	0.78	1.57	2.87-3.01
	M4 x 0.7	M4	6.35	6.35	6.35	5.74	1.16	1.57	3.25-3.42
	M5 x 0.8	M5	7.13	7.13	7.13	6.57	1.16	1.57	4.15-4.34
	M6 x 1.0	M6	9.53	9.53	8.74	8.15	1.57	2.38	4.94-5.16
	M10 x 1.5	M10	14.27	14.27	12.70	11.84	2.38	2.38	8.55-8.67

(1) All dimensions are in millimeters and reference unless toleranced.

INSTALLATION

The MTZ Molded Thru-hole Zert is designed to be molded into the host plastic using a core pin to locate the insert in the mold. A good fit between the core pin and insert will prevent plastic from flowing into the threads.

PERFORMANCE

INCH	Insert Thread Code	Host Material	Pull-out (lbs)	Torque-out (in-lbs)
	080 256	ABS	96-104	5.2-5.6
		Polycarbonate	106-115	5.6-6.0
	440	ABS	166-175	5.5-6.0
		Polycarbonate	173-186	6.2-6.9
	632	ABS	290-298	7.5-8.0
		Polycarbonate	302-318	8.5-9.0
	832	ABS	368-370	13.6-14.0
		Polycarbonate	372-382	14.7-16.0
	1024 1032	ABS	432-444	50-55
Polycarbonate		445-454	52-57	
2520 2528	ABS	620-635	75-70	
	Polycarbonate	635-650	98-103	

(1) Performance data shown is for reference only. Variations in application, boss material type and size, and installation method will affect the loads. PENCOM strongly encourages testing in the application.

METRIC	Insert Thread Code	Host Material	Pull-out (kN)	Torque-out (N-m)
	M2	ABS	0.43-0.46	0.59-0.63
		Polycarbonate	0.47-0.51	0.63-0.68
	M2.5 M3	ABS	0.73-0.77	0.62-0.67
		Polycarbonate	0.76-0.82	0.70-0.77
	M4	ABS	1.63-1.64	1.53-1.58
		Polycarbonate	1.65-1.69	1.66-1.80
	M5	ABS	1.92-1.97	5.65-6.22
		Polycarbonate	1.97-2.01	5.87-6.44
	M6	ABS	2.75-2.82	7.91-8.47
		Polycarbonate	2.82-2.89	11.0-11.6

(1) Performance data shown is for reference only. Variations in application, boss material type and size, and installation method will affect the loads. PENCOM strongly encourages testing in the application.

OPTIONS

Custom Designs

PENCOM's Application Engineers have many years of fastener experience and can assist in identifying a standard insert or creating a custom product to meet your requirements. Special designs include non-standard threads, lengths and diameters, and unique knurl and external feature configurations to name a few.



Special Materials and Finishes

In addition to standard plain-finished brass, stainless steel and aluminum, PENCOM can manufacture inserts in carbon and gall-resistant stainless steels, and with a variety of attractive finishes such as nickel and zinc with clear or colored chromates.



Thread Locking and Lubricating

A variety of thread locking and lubricating materials can be applied to insert and stud threads. Nylon (shown), micro-encapsulated epoxy and other locking elements prevent loosening due to vibration. Lubricating coatings reduce friction, heat buildup and galling during installation of mating fasteners.





“Manufactured globally, supplied locally”

For inquiries please contact: sales@pencomsf.com
or visit our website at www.pencomsf.com

