

Surface-Mount Standoffs

FEATURES

- Threaded standoffs installed on p.c. boards at the same time and method as other surface-mount technology (SMT) components.
- Reduce secondary handling of p.c. boards that may lead to potential damage.
- Packaged on tape and reel consistent with standard automated SMT installation equipment.
- Available in a wide variety of thread sizes and lengths.

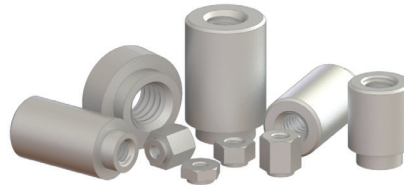

PART DESCRIPTION EXAMPLE

TCUST - 440 - .250 - TIN - MATTE

Material Thread Length
 Code Code

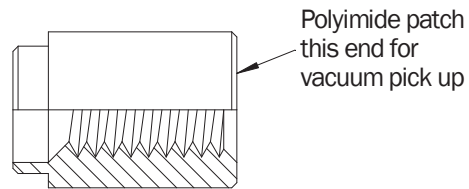
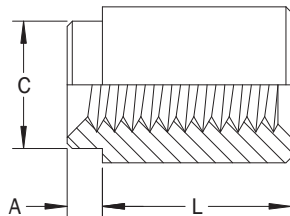
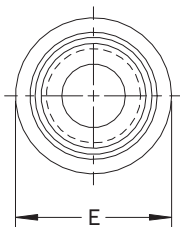

Thread sizes 2-56, 4-40, 6-32, 8-32, M2, M2.5, M3, M3.5, M4
(see note on page 3 regarding counterbore)

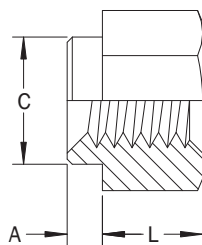
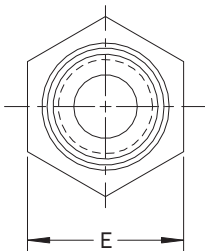

Polyimide patch
this end for
vacuum pick up

Thread sizes 0-80, S1, S1.2, S1.4 and M1.6

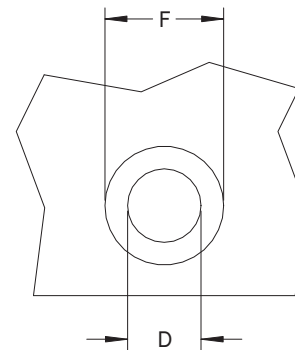

Solder Pad

TCU Surface-Mount Standoffs

GENERAL

All dimensions in inches

INCH	Thread	Thread Code	Sheet			A Max.	C Max.	E ±.005
			Min. Thickness	D Hole Size +.003 -.000 ²	F Min. Solder Pad Dia.			
	0-80	080	.020	.098	.165	.019	.095	.125
	2-56	256	.060	.147	.244	.060	.142	.219
	4-40	440	.060	.166	.244	.060	.161	.219
	6-32	632	.060	.213	.306	.060	.208	.281
	8-32	832	.060	.250	.369	.060	.245	.344

All dimensions in millimeters

METRIC	Thread	Thread Code	Sheet			A Max.	C Max.	E ±0.13
			Min. Thickness	D Hole Size +0.08 -0.00 ²	F Min. Solder Pad Dia.			
	S1 ¹	M1	0.50	2.50	4.19	0.48	2.41	3.18
	S1.2 ¹	M1.2	0.50	2.50	4.19	0.48	2.41	3.18
	S1.4 ¹	M1.4	0.50	2.50	4.19	0.48	2.41	3.18
	M1.6 x 0.35	M1.6	0.50	2.50	4.19	0.48	2.41	3.18
	M2 x 0.4	M2	1.53	3.73	6.20	1.53	3.60	5.56
	M2.5 x 0.45	M2.5	1.53	4.22	6.20	1.53	4.09	5.56
	M3 x 0.5	M3	1.53	4.22	6.20	1.53	4.09	5.56
	M3.5 x 0.6	M3.5	1.53	5.41	7.77	1.53	5.28	7.14
	M4 x 0.7	M4	1.53	6.35	9.37	1.53	6.22	8.74

(1) Miniature threads per ISO 1501 4H6.

(2) Thru-plating not required on sheet hole.

TCU Surface-Mount Standoffs

LENGTH

All dimensions in inches

INCH	Thread	L (Length) ± .005			
	0-80	.062	.125	--	--
2-56	.062	.125	.250 ¹	.375 ¹	
4-40	.062	.125	.250 ¹	.375 ¹	
6-32	.062	.125	.250 ¹	.375 ¹	
8-32	.062	.125	.250 ¹	.375 ¹	

All dimensions in millimeters

METRIC	Thread	L (Length) ± 0.13						
	S1	1	2	3	--	--	--	--
S1.2	1	2	3	--	--	--	--	
S1.4	1	2	3	--	--	--	--	
M1.6 x 0.35	1	2	3	--	--	--	--	
M2 x 0.4	--	2	3	4 ¹	6 ¹	8 ¹	10 ¹	
M2.5 x 0.45	--	2	3	4 ¹	6 ¹	8 ¹	10 ¹	
M3 x 0.5	--	2	3	4 ¹	6 ¹	8 ¹	10 ¹	
M3.5 x 0.6	--	2	3	4 ¹	6 ¹	8 ¹	10 ¹	
M4 x 0.7	--	2	3	4	6 ¹	8 ¹	10 ¹	

(1) Standoffs of this length with material code BR have a counterbored shank.

(2) Custom lengths by request.

MATERIAL AND FINISH

Material Code	Material Description	Finish Description
BR	Brass	Electroplated Matte Tin per ASTM B545, Class A with Clear Preservative Coating, Annealed
ST	Carbon Steel	Electroplated Matte Tin per ASTM B545, Class A with Clear Preservative Coating, Annealed

INSTALLATION

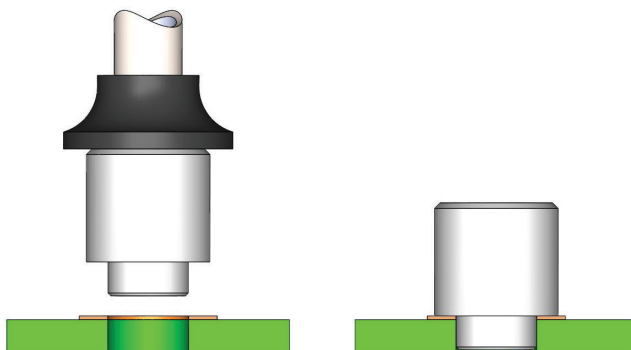

Apply solder paste to p.c. board pad. Place fastener by gripping end with polyimide patch.

Solder fastener in place using surface-mount technology (SMT) practices.

TCU Surface-Mount Standoffs

REEL DATA

All dimensions in inches

INCH	Thread	Length			
		.062	.125	.250	.375
	Parts per Reel/Pitch				
0-80		3500/.315	2000/.315	--	--
2-56		1500/.472	1000/.472	650/.472	300/.630
4-40		1500/.472	1000/.472	650/.472	300/.630
6-32		1500/.472	1000/.472	650/.472	300/.630
8-32		1100/.630	800/.630	500/.630	300/.630

All dimensions in millimeters

METRIC	Thread	Length						
		1	2	3	4	6	8	10
	Parts per Reel/Pitch							
S1		3500/8	2500/8	2000/8	--	--	--	--
S1.2		3500/8	2500/8	2000/8	--	--	--	--
S1.4		3500/8	2500/8	2000/8	--	--	--	--
M1.6 x 0.35		3500/8	2500/8	2000/8	--	--	--	--
M2 x 0.4		--	1500/12	1000/12	900/12	650/12	375/16	300/16
M2.5 x 0.45		--	1500/12	1000/12	900/12	650/12	375/16	300/16
M3 x 0.5		--	1500/12	1000/12	900/12	650/12	375/16	300/16
M3.5 x 0.6		--	1500/12	1000/12	900/12	650/12	375/16	300/16
M4 x 0.7		--	1100/16	800/16	675/16	500/16	375/16	300/16

- (1) Parts packaged on .945" (24mm) wide tape on 13" (330mm) recyclable reels conforming to EIA-481.
- (2) Parts available in bulk without polyimide patch by special request.



TCU Surface-Mount Standoffs

PERFORMANCE

INCH	Thread	Push-out (lbs)	Torque-out (in-lbs)
	0-80	85.1	4.94
	2-56	56.5	8.56
	4-40	56.5	8.56
	6-32	93.5	13.83
	8-32	151.1	26.96

(1) Performance and test information are based on commonly reported industry values and for reference purposes only. Actual performance may vary depending on conditions. PENCOM strongly encourages testing in the application.

METRIC	Thread	Push-out (N)	Torque-out (N-m)
	S1	378.7	0.56
	S1.2	378.7	0.56
	S1.4	378.7	0.56
	M1.6 x 0.35	378.7	0.56
	M2 x 0.4	251.0	1.0
	M2.5 x 0.45	251.0	1.0
	M3 x 0.5	251.0	1.0
	M3.5 x 0.6	416.0	1.6
	M4 x 0.7	672.0	3.0

(1) Performance and test information are based on commonly reported industry values and for reference purposes only. Actual performance may vary depending on conditions. PENCOM strongly encourages testing in the application.

TEST PARAMETERS

Test Sheet Material

.062" (1.57mm) Single Layer FR-4

Max. Oven Temp.

473°F (245°C)

Test Sheet Finish

62%Sn, 38%Pb

Vias

None

Pattern

Two spoke

Paste (Lead-Free)

Amtech Sn96.5/Ag3.0/Cu0.5 (SAC305)

Stencil Thickness

.0067" (0.17mm)

TCU Surface-Mount Standoffs